

Operating Manual

English



QUANTUM^X



托驰（上海）工业传感器有限公司
上海市嘉定区华江路348号1号楼707室
电话: +86 021 51069888
传真: +86 021 51069009
邮箱: zhang@yanatoo.com
网址: www.sensor-hbm.com

Subject to modifications.
All product descriptions are for general information only.
They are not to be understood as a guarantee of quality or
durability.

4	Introduction	18
4.1	About the QuantumX documentation	18
4.2	The QuantumX family	19
4.3	Module overview/transducer technologies	23
4.4	Digitalization and signal path	24
4.5	Synchronization	25
5	Software	32
5.1	MX Assistant	32
5.2	catman®AP	33
5.3	LabVIEW® driver / library	35
5.4	Driver for Microsoft® Visual Studio .NET	35
5.5	Other drivers	36
5.6	Firmware update via Ethernet	36
7	Connecting individual QuantumX modules	54
7.1	Connecting the supply voltage	54
7.2	Connection to host PC or data recorder	56
7.2.1	Single Ethernet connection	56
7.2.2	Multiple Ethernet connection with PTP synchronization	57
7.2.3	Multiple Ethernet connection and FireWire synchronization	58
7.2.4	Connecting one or more QuantumX modules to the PC	58
7.2.5	Firmware update via Ethernet	65
7.2.6	Connection via FireWire (IEEE 1394b)	66
7.2.7	Setting up FireWire 1394b on the PC	67
7.2.8	Multiple FireWire connection	69
7.2.9	Layout with data recorder CX22B-W	70
7.2.10	Output measurement signals to CAN bus (MX840B)	71
7.2.11	Output measurement signals to CAN bus (MX471B)	71
7.2.12	Output of signals with standardized voltage in real time (MX878B or MX879B)	72
7.2.13	Output signals in real time via EtherCAT® or PROFINET IRT and in parallel via Ethernet	74

7.2.14	QuantumX in the FireWire group	75
8	Modules and transducers	76
8.1	General information	76
8.1.1	Shielding design	76
8.1.2	Active transducer connection	78
8.1.3	TEDS	79
8.1.4	Background calibration / autoadjustment	82
8.2	MX840/A/B universal amplifier	84
8.2.1	MX840B pin assignment	86
8.2.2	MX840B status display	87
8.3	MX440B universal amplifier	88
8.4	MX410B highly dynamic universal amplifier	90
8.4.1	MX410B pin assignment	91
8.4.2	MX410B status display	92
8.5	MX430B Strain gage fullbridge measuring amplifier	94
8.5.1	MX430B pin assignment	94
8.5.2	MX430B status display	95
8.6	MX238B Strain gage fullbridge measuring amplifier	97
8.6.1	MX238B pin assignment	97
8.6.2	MX238B status display	98
8.7	MX460B frequency amplifier	100
8.7.1	MX460B pin assignment	100
8.7.2	MX460B status display	102
8.8	MX1609KB and MX1609TB thermocouple amplifier	103
8.8.1	Thermocouple with TEDS functionality (RFID)	104
8.8.2	MX1609 status display	105
8.9	MX471B/C CAN module	107
8.9.1	General information	107
8.9.2	MX471B/C pin assignment	108
8.9.3	MX471B status LEDs	109
8.9.4	Receiving CAN messages	110
8.10	MX1601B amplifier	111
8.10.1	MX1601B pin assignment	112

8.10.2	MX1601B status display	113
8.11	MX1615B amplifier	115
8.11.1	MX1615B pin assignment	116
8.11.2	MX1615B status display	118
9	Transducer connection	120
9.1	Full bridge, SG	120
9.2	Full bridge, inductive	121
9.3	Full bridge, piezoresistive	122
9.4	Half bridge, SG	124
9.5	Half bridge, inductive	126
9.6	Quarter bridge, SG	127
9.7	Adapter quarter bridge, SG	128
9.8	Connecting transducers with double shield technique	129
9.9	Potentiometric transducers	130
9.10	LVDT transducers	131
9.11	Current-fed piezoelectric transducer (ICP/IEPE)	132
9.12	Electrical voltage 100 mV	134
9.13	DC voltage sources 10 V	135
9.14	DC voltage sources 60 V	136
9.15	Voltage sources up to 300 V (CAT II)	137
9.16	DC current sources 20 mA	138
9.17	DC current sources 20 mA - voltage-fed	139
9.18	Ohmic resistance (e.g. PTC, NTC, KTY, ...)	140
9.19	Resistance thermometer PT100, PT1000	141
9.20	Thermocouples	142
9.21	Frequency, differential, without directional signal	145
9.22	Frequency, differential, with directional signal	146
9.23	Frequency, single-pole, without directional signal	147
9.24	Frequency, single-pole, with directional signal	148
9.25	Encoder and pulse encoder, differential	149
9.26	Encoder and pulse encoder, single-pole	150
9.27	Rotary encoder and pulse generator, single pole with static directional signal	151

9.28	Absolute value encoder with SSI protocol	152
9.29	Passive inductive encoder (Pickups, Crankshaft sensor)	154
9.30	Measurement of rotational speed, Crankshaft sensor (digital, TTL)	155
9.31	PWM - Pulse width, pulse duration, period duration	156
9.32	PWM - Pulse width, pulse duration, period duration, single-pole	157
9.33	CAN bus	158
10	Functions and outputs	160
10.1	Amplifier with analog outputs	161
10.2	MX460B	164
10.3	MX878B	165
10.4	MX879B Multi-I/O module	171
10.5	MX471B	177
11	FAQ	178
12	Accessories	181
12.1	System accessories	190
12.1.1	BPX001 backplane	190
12.1.2	BPX002 backplane	190
12.1.3	Housing connection elements	191
12.2	Voltage supply	192
12.2.1	Power pack NTX001	192
12.2.2	Supply cable	192
12.3	IEEE1394b FireWire	193
12.3.1	IEEE1394b FireWire cable (module-to-module; IP67)	193
12.3.2	Connection cable (PC to module)	193
12.3.3	Connection cable (PC to hub)	194
12.4	General information	195
12.4.1	Plug kit with TEDS chip	195
12.4.2	Port saver Sub-HD 15-pin	195
12.4.3	Adapter D-Sub-HD 15-pin to D-Sub 15-pin	196
12.5	Accessories for MX840B, MX440B	196
12.5.1	Cold junction for thermocouples	196
12.6	SubHD15 to BNC adapter	197

12.7	SCM-HV accessories	198
12.8	SCM-SG120/350 quarter bridge adapter	198
12.9	MX1609/KB/TB accessories	199
12.9.1	Thermo-connector with integrated RFID chip	199
13	Support	200

1 Safety instructions

Notice

The safety instructions described here also apply to the power pack NTX001 and the active backplane BPX001 and BPX002.

Appropriate use

A module with connected transducers is to be used exclusively for measurement tasks and Test tasks. Use for any purpose other than the above is deemed to be non-designated, inappropriate use.

In the interests of safety, the module should only be operated as described in the Operating Manuals. It is also essential to comply with the legal and safety requirements for the application concerned during use. The same applies to the use of accessories.

Before commissioning the module for the first time, you must first run a project planning and risk analysis that takes into account all the safety aspects of automation technology. This particularly concerns personal and machine protection.

Additional safety precautions must be taken in plants where malfunctions could cause major damage, loss of data or even personal injury. In the event of a fault, these precautions establish safe operating conditions.

This can be done, for example, by mechanical interlocking, error signaling, limit value switches, etc.

Notice

The module must not be connected directly to a power supply system. The supply voltage must be 10 V ... 30 V (DC).

General dangers of failing to follow the safety instructions

Every module is a state of the art device and as such is failsafe. The module may give rise to residual dangers if it is inappropriately installed and operated by untrained personnel. Any person instructed to carry out installation, commissioning, maintenance or repair of the modules must have read and understood the Operating Manuals and in particular the technical safety instructions.

The scope of supply and performance of the modules only covers a small area of measurement technology. In addition, equipment planners, installers and operators should plan, implement and respond to the safety engineering considerations of measurement technology in such a way as to minimize residual dangers. On-site regulations must be complied with at all times. There must be reference to the residual dangers connected with measurement technology. After making settings and carrying out activities that are password-protected, you must make sure that any controls that may be connected remain in safe condition until the switching performance of the module has been tested.

Conditions on site

For modules in the housing with degree of protection IP20:

- Protect the modules from dirt and moisture or the effects of weather such as rain, snow, etc.
- The permissible relative humidity at 31 °C is 80% (non-condensing); linear reduction to 50% at 40 °C.
- Make sure that the side ventilation openings are not covered.

For all modules:

- Do not expose the modules to direct sunlight.
- Please observe the permissible maximum ambient temperatures stated in the specifications.
- Ensure there is adequate ventilation for installation in the BPX001 back-plane.

Maintenance and cleaning

The modules are maintenance-free. Please note the following points when cleaning the housing:

- Before cleaning, disconnect all connections.
- Clean the housing with a soft, slightly damp (not wet!) cloth. *Never* use solvent as this could damage the labeling or the housing.
- When cleaning, ensure that no liquid gets into the module or connections.

Outputs

Particular attention must be paid to safety when using the digital, analog or CAN bus outputs of a module. Ensure that status or control signals cannot initiate any actions that may pose a danger to persons or the environment.

Product liability

In the following cases, the protection provided for the device may be adversely affected. Liability for device functionality then passes to the operator:

- The device is not used in accordance with the operating manual.
- The device is used outside the field of application described in this section.
- The operator makes unauthorized changes to the device.

Warning signs and danger symbols

Important instructions for your safety are specifically identified. It is essential to follow these instructions in order to prevent accidents and damage to property.

Safety instructions are structured as follows:



WARNING



Type of danger

Consequences of non-compliance

Averting the danger

- **Warning sign:** draws attention to the danger
- **Signal word:** indicates the severity of the danger (see table below)
- **Type of danger:** identifies the type or source of the danger
- **Consequences:** describes the consequences of non-compliance
- **Defense:** indicates how the danger can be avoided/bypassed.

Danger classes as per ANSI

Warning sign, signal word	Meaning
	This marking warns of a <i>potentially</i> dangerous situation in which failure to comply with safety requirements may result in death or <i>serious physical injury</i> .
	This marking warns of a <i>potentially</i> dangerous situation in which failure to comply with safety requirements <i>may result in slight or moderate physical injury</i> .
	This marking draws your attention to a situation in which failure to comply with safety requirements <i>may lead to damage to property</i> .

Working safely

The supply connection, as well as the signal and sensor leads, must be installed in such a way that electromagnetic interference does not adversely affect device functionality (HBM recommendation: "Greenline shielding design", downloadable from the Internet at <http://www.hbm.com/Greenline>).

Automation equipment and devices must be covered over in such a way that adequate protection or locking against unintentional actuation is provided (e.g. access checks, password protection, etc.).

When devices are working in a network, these networks must be designed in such a way that malfunctions in individual nodes can be detected and shut down.

Safety precautions must be taken both in terms of hardware and software, so that a line break or other interruptions to signal transmission, e.g. via the bus interfaces, do not cause undefined states or loss of data in the automation device.

Error messages should only be acknowledged once the cause of the error is removed and no further danger exists.

Conversions and modifications

The module must not be modified from the design or safety engineering point of view except with our express agreement. Any modification shall exclude all liability on our part for any resultant damage.

In particular, any repair or soldering work on motherboards (exchanging components) is prohibited. When exchanging complete modules, use only original parts from HBM.

The module is delivered from the factory with a fixed hardware and software configuration. Changes can only be made within the possibilities documented in the manuals.

Qualified personnel



Important

This device is only to be installed and used by qualified personnel strictly in accordance with the specifications and with the safety rules and regulations which follow.

Qualified persons means persons entrusted with the installation, fitting, commissioning and operation of the product who possess the appropriate qualifications for their function. This module is only to be installed and used by qualified personnel, strictly in accordance with the specifications and the safety rules and regulations.

This includes people who meet at least one of the three following requirements:

- Knowledge of the safety concepts of automation technology is a requirement and as project personnel, you must be familiar with these concepts.
- As automation plant operating personnel, you have been instructed how to handle the machinery and are familiar with the operation of the modules and technologies described in this documentation.

- As commissioning engineers or service engineers, you have successfully completed the training to qualify you to repair the automation systems. You are also authorized to activate, ground and label circuits and equipment in accordance with safety engineering standards.

It is also essential to comply with the legal and safety requirements for the application concerned during use. The same applies to the use of accessories.

2 Electro magnetic conformity

Additional information about the relevant EMC standards EN 61326-1 / EN61326-2-x.

These standards define emissions limits and immunity requirements for different environments.

Emissions requirements are defined for the following environments:

- Industrial (Class A) or
- Residential / Laboratory (Class B).

The standard refers to CISPR 11:2009+A1:2010.

Immunity requirements are defined for the following environments:

- Controlled electro-magnetic (lowest requirements)
- Basic or
- Industrial (highest requirements).

The modules listed in the declaration of conformity comply with the requirements for the following environments:

Emissions: Class A

Immunity: Industrial environment

The QuantumX series and its modules are intended for use in an industrial environment. When used in residential or commercial environments, additional arrangements may be required to limit electro-magnetic emissions.

An example is voltage supply of the modules by **battery**. In this case please wrap the power supply cable (KAB271-3) around the inductive coil included in the package four times.







When the NTX001 power supply from HBM is used, the system complies with **Emissions: Class B** without the necessity to carry out the measurement described above.

3 Markings used

3.1 The markings used in this document

Important instructions for your safety are specifically identified. It is essential to follow these instructions, in order to prevent damage.

Symbol	Meaning
	This marking draws your attention to a situation in which failure to comply with safety requirements <i>may lead to damage to property</i> .
	This marking warns of a <i>potentially</i> dangerous situation in which failure to comply with safety requirements <i>may result in slight or moderate physical injury</i> .
	This marking draws your attention to <i>important</i> information about the product or about handling the product.
	This marking indicates application tips or other information that is useful to you.
Device -> New	Bold text indicates menu items, as well as dialog and window titles in the user interfaces. Arrows between menu items indicate the sequence in which the menus and sub-menus are opened.
<i>Sampling rate, 500</i>	Bold text in italics indicates inputs and input fields in the user interfaces.
<i>Emphasis</i> <i>See ...</i>	Italics are used to emphasize and highlight text and identify references to sections, diagrams, or external documents and files.

3.2 Symbols on the device

CE marking



CE marking enables the manufacturer to guarantee that the product complies with the requirements of the relevant EC directives (the Declaration of Conformity can be found on the HBM website (www.hbm.com) under HBM-doc).

Statutory waste disposal mark



In accordance with national and local environmental protection and material recovery and recycling regulations, old devices that can no longer be used must be disposed of separately and not with normal household garbage.

Electrostatically sensitive components



Components marked with this symbol can be damaged beyond repair by electrostatic discharge. Please observe the handling instructions for components exposed to the risk of electrostatic discharge.

4 Introduction

4.1 About the QuantumX documentation

The QuantumX family documentation consists of

- a printed quick start guide for initial start-up
- the data sheets in PDF format
- This operating manual in PDF format
- the operating manual for the EtherCAT®³¹⁾ / PROFINET / Ethernet gateways CX27B/C in PDF format
- the operating manual for data recorder CX22B-W and CX22B data recorders
- the operating manual for CAN FD / CAN-Bus
- the operating manual for the MX403B and MX809B modules for safe measurement at high potential
- the operating instructions for the Signal Conditioning Modules (SCM)
 - High-voltage signal conditioned SCM-HV (300 V CAT II)
 - Quarter bridge adapter SCM-SG-120 / -350 /-700 /-1000 for connecting SGs individually
- the product descriptions for accessories
- a comprehensive online help with index and easy search options which is available after the installation of a software package (e.g. MX Assistant, catman®AP or or EVIDAS). Information about module and channel configuration can also be found here.

These documents can be found

- on the QuantumX system CD supplied with the device
- After installation of the MX Assistant on the hard drive of your PC, which can be reached through the Windows start menu
- Up-to date versions are always available from our Internet site at www.hbm.com/hbmdoc

¹⁾ EtherCAT® is a registered brand and patented technology, licensed by Beckhoff Automation GmbH, Germany

4.2 The QuantumX family

The QuantumX family is a modular measurement system for universal applications. The modules can be individually combined and intelligently connected according to the measurement task. Distributed operation makes it possible to position individual modules close to the measuring points, resulting in short sensor lines.

The QuantumX family consists of the following modules:

- *MX840B* Universal amplifier
The module has 8 universal inputs and supports more than 15 transducer technologies.
- *MX440B* Universal amplifier
Like the MX840B, but with 4 inputs (connections 5-8 of MX840B, without CAN).
- *MX410B* Highly dynamic universal amplifier
The module has 4 universal inputs and supports commonly used transducer technologies (at a sampling rate of up to 96,000 measured values per channel per second).
- *MX430B QuantumX* precision bridge measurement module. The module has 4 inputs and supports full bridge SG-based transducers with an accuracy class of 100 ppm.
- *MX238B* Precision full bridge amplifier
The module has 2 full bridge SG inputs with an accuracy of 25 ppm.
- *MX460B* Digital module (counter, frequency, timer)
The module has 4 individually configurable inputs for connecting HBM torque measurement shafts (T12, T40, T10), rotational speed sensors, crankshaft sensors with gap (TDC sensor), pulse width modulated signals - PWM.
- *MX471C* CAN FD module
The module has four CAN FD / CAN nodes that can be configured to receive CAN FD messages.
- *MX471B* CAN module
The module has 4 CAN bus nodes that can be configured for receiving and sending messages. The module supports the CCP and xCP-on-CAN protocols on up to 2 channels.

- **MX1601B** Analog amplifier (standardized voltage / current, IEPE)
The module has 16 individually configurable inputs for standardized voltage or current measurement or for connecting current-fed piezoelectric transducers (IEPE / ICP(R)).
- **MX1615B/MX1616B** SG bridge amplifier
The module has 16 individually configurable inputs for SGs in quarter, half and full bridge circuits. Bridge excitation voltage DC or carrier frequency (1200 Hz).
- **MX1609KB** Thermocouple amplifier
The module has 16 inputs for type K thermocouples.
- **MX1609TB** Thermocouple amplifier
The module has 16 inputs for type K thermocouples.
- **MX809B** Thermo measurement module
The module has 8 inputs for measurement of temperatures with thermocouples or electrical cell voltages up to 5 V at a potential up to 1000 V in energy storage systems. General measurement categories: 600 V CAT II, 300 V CAT III.
The module and entire production have been certified by VDE, and stand for maximum safety when working with dangerous voltages.
- **MX403B** voltage module
The module has 4 inputs with lab connectors for voltage measurement (1000 V CAT II, 600 V CAT III).
The module and entire production have been certified by VDE, and stand for maximum safety when working with dangerous voltages.

Notice

When using the modules MX403B or MX809B, please refer to the separate operating manual, document number A3757.

- **CX22B** or **CX22B-W** (WLAN) Data recorder
The module is used for local recording of measurement data.
- **CX27B/C** EtherCAT®/PROFINET IRT and Ethernet gateway
The module is used to connect QuantumX modules to the fieldbus EtherCAT or the Ethernet.

- *MX878B* Analog output module
The module has 8 scalable voltage outputs (± 10 V) that can be assigned with a system signal or a source signal. Signals can also be calculated in real time.
- *MX879B* Multi-I/O module
The module has 8 scalable voltage outputs and 32 configurable digital inputs/outputs. Signals can also be calculated in real time.

All modules have the following in common:

- Supply voltage range 10 ... 30 V DC (nominal rated voltage 24 V DC)
- Configurable Ethernet interface for data communication with an operating PC
- 2 IEEE1394b FireWire interfaces
 - For optional voltage supply
 - For optional data communication with a PC
 - For automatic time synchronization of the modules
 - For real-time transfer of measurement data between the modules
- Connector for installation on a backplane (not applicable for ultra-robust variants)
- Status LEDs for displaying general system and channel states
- A factory calibration certificate is stored on each amplifier, which can be read by the QuantumX Assistant.
- AutoBoot (module configurations are retained)

With amplifiers, the following applies for each measurement channel:

- Galvanic isolation (signal inputs/outputs, voltage supply, communication)
- Configurable supply voltage for active sensors
- Support for TEDS²⁾ technology (read, write)
- Configurable sampling rate
- Configurable digital filter (Bessel, Butterworth)
- configurable scaling

²⁾ TEDS = Transducer Electronic Data Sheet

Sensors assigned using the sensor database can be calibrated via the channel and written back into the sensor database.

4.3 Module overview/transducer technologies

QuantumX Module Overview																
Kanaltzahl	Inputs / Measurement Modules											System				
	Universal			Precision		M/n	CAN	High Channel Count		Isolated		Recorder / Gateway	Gateway	Multi IO		
	MX1609B	MX440B	MX110B	MX490B	MX238B	MX460B	MX471B	MX110/1B	MX115B	MX1609 1)	MX309B	MX403B	CC22B-W	CC27B	MX678B	MX679B
Messrate [kS/s]	40	40	100	40	40	100	-	16	16	16	8	4	-	-	8	8 + 32
El. Voltage	•	•	•					•	•							
El. Voltage, isolated 5 V (CAT II / III)	• ²⁾	• ²⁾	• ²⁾								•	•				
El. Voltage 10, 100, 1000 V (CAT II / III)												•				
El. Current (0 / 4 ... 20 mA)	•	•	•					•								
Strain gage full bridge	•	•	•	•	•				•							
Strain gage half bridge	•	•	•						•							
Strain gage quarter bridge	• ³⁾	• ³⁾	• ³⁾	• ³⁾	• ³⁾				•							
Inductive full bridge	•	•	•													
Inductive half bridge	•	•	•													
LVDT	•	•														
Potentiometer	•	•							•							
SSI absolute encoder (protocol)	•	•														
Current fed piezo electric (IEPE, ICP [®])	•	•	•					•								
Piezo resistive transducer	•	•	•													
Thermocouple	•	•								•	•					
Thermometer, RTD, PT	•	•														
Resistance input (R)	•	•							•							
Frequency, pulse count (timer, TTL)	•	•					•									
Inkremental encoder (timer, TTL)	•	•					•									
Inductive pick-up (AC coupled), crank							•									
Pulse-width measurement (timer)							•									
Analog output (+/- 10 V)			•	•											•	•
Digital input (static)													•	•		•
Digital output (static)													•	•		•
CANbus (receive, transmit)	•							•								
CCP / xCP-on-CAN								•								
Ethernet CAT														•		
GPS connection (RS232, USB)													•			
Data recording													•			

1) MX1609KB supports thermocouple type K, MX1609TB = thermocouple type T.
 2) with isolated voltage adapter SCM-IHV.
 3) with quarter bridge adapter SCM-SG120 or SCM-SG350.

See data sheets for precise technical specifications. The pin assignments can be found in the following chapters.

4.4 Digitalization and signal path

Data rate

QuantumX measurement modules with the suffix B, like the MX840B, for instance, have decimal data rates such as 600, 1200,19,200 S/sec available, in addition to classic data rates such as 500, 1000, 100,000 S/sec.

When there are several modules in a group, the selected data rate domains must be identical. Catman® or MX Assistant software allows toggling the sample rate domain, e.g. From „Classic“ to „Decimal“.

Signal paths

Synchronizing the acquisition of all channels allows signal analysis of all recorded measurement data at the same time.

It often happens that some sensor signals should be made available in real time, in parallel with the data analysis of high-frequency signals (e.g. 100 kS/sec per channel), i.e. deterministically, with a moderate data rate (e.g. 1 kS/sec or 1 ms control loop) and with a minimum latency time (e.g. max. 1 ms).

To do this, the modules need to be connected with each other via the FireWire bus and the signals need to be made available "isochronously", for example, to be computed and/or output via another module (analog, CAN, EtherCAT).

To give this parallel operation optimum support, each QuantumX measurement channel generates two signals.

The maximum isochronous data rate per channel is approx. 5 kS/sec (125 μ s clock pulse on the FireWire bus).

Scaling

QuantumX supports the following types of scaling:

- Two points (2-point / $y=mx+b$)
- Table (multi-point) supported from MX840B, MX440B, MX1609/KB/TB, MX809B
- Polynomial, supported from MX840B, MX440B, MX440B, MX430B, MX238B

The 16-channel modules (MX1601B and MX1615B) as well as modules MX403B and MX460B only support two-point scaling.

4.5 Synchronization

If measurement signals need to be referenced over time with each other for processing and analysis, they must be recorded synchronously.

All QuantumX modules can be synchronized among themselves. This ensures simultaneous measurement on all channels. All the analog-digital converter rates, measuring rates and bridge excitation voltages are therefore also synchronized.

Synchronization methods:

Synchronisation via Ethernet IEEE1588:2008 (PTPv2)

When modules such as the MX840B are set to this synchronization mode and interconnected using a switch with PTP capability, they automatically synchronize with each other or a Grandmaster Clock. Transparent Clock (TC) mode is supported here.

The following setup parameters are available:

- Time delay: End-2-End (E2E) or Peer-2-Peer (P2P)
- Transport protocol: IPv4 or IPv6

Modules that do not support this mode, such as MX840A can be connected via FireWire to the adjacent module with PTPv2, and included in the synchronization (automatic clock distribution).

The converted modules must be restarted. The system as a whole therefore supports the classic HBM sample rates only.

Converted modules need to be restarted. After restart, check the system LEDs at the module front - green means synchronous.

Synchronization via IEEE1394b FireWire

All the modules are synchronized automatically when they are connected via the IEEE1394b FireWire cable.

No CX27/B module present in the system and no external synchronization source available:

The module with the highest serial number (UUID) takes over the master function.

CX27/B module present in the system and no external synchronization source available:

If a CX27/B module is connected, it automatically becomes the synchronization master. When starting the system, the system time is set once to the actual time.

If QuantumX modules alone are being used, internal synchronization is sufficient. However, if synchronous measurements are to be performed by different measurement systems, an external master must be used for synchronization.

Synchronization with external sources

In an external synchronization source is set, the module with the best synchronization quality automatically becomes the master and synchronizes all modules connected via IEEE1394b FireWire.

If several external sources are selected, the system decides according to the following priorities:

1. EtherCAT®
2. IRIG-B
3. NTP

Synchronization via EtherCAT®

The CX27 gateway supports the “Distributed Clocks” expansion of EtherCAT®. The time is distributed to all EtherCAT® nodes in an EtherCAT® group.

The CX27 module can be synchronized to the EtherCAT® time. This will mean that all the QuantumX module clocks are synchronized to this time.

Synchronization via an NTP server

Each QuantumX module can synchronize its internal clock with an NTP server. The NTP time is distributed to the other modules via IEEE1394b FireWire.

It is possible to achieve accuracies of 1 ms or higher, depending on the utilization of the network and on whether or not a dedicated NTP master is being used.

Modules located close together should be synchronized via IEEE1394b FireWire.

If the synchronization source for a module is changed to NTP, the system must be restarted once. The HBM catman®EASY software includes an NTP software package.

Parameter:

- IP address of the NTP server
- Threshold in μ s below which the time deviation to NTP time is tolerated

Further information about NTP can be found at <http://www.ntp.org>

Synchronization via IRIG-B

IRIG-B is a standardized time coding.

To time-synchronize the QuantumX system, the digital or analog modulated time signal is sent externally to any analog voltage input of the amplifier type MX840B or MX440B (see Assignment, section 8.2.1).

The B127 format uses analog modulation. Connection is identical to that of a 10-V voltage sensor.

The other formats are BCD-coded and must be connected analog to the sensor "Frequencies single-pole, without directional signal", see section 9.30.

The amplifiers can record IRIG-B signals of type B000 to B007 and B120 to B127. All modules connected via IEEE1394b FireWire are also automatically synchronized. The coding includes the time, year and optionally the seconds of the day.

Comparison of synchronization mechanisms

Feature	IEEE1394b FireWire	Ethernet (PTPv2)	Ethernet (NTP)	EtherCAT®	IRIG-B
Synchronization with other device types	QuantumX only	QuantumX B module GENESIS Cameras	QuantumX, MGCplus other interrogators	All EtherCAT® nodes	All IRIG-B nodes
Max. distance between QuantumX modules	5 m (40 m with IEEE1394b FireWire extender, 500 m via optical fiber)	100 m electrical and up to a few 100 m optical	100 m electrical, several km optical, variable with WLAN	100 m	-
Number of modules to be synchronized	24	Unlimited	Unlimited	CX27 required, unlimited	Unlimited MX440B, MX840B required,
Synchronization accuracy	< 1 μ s	< 1 μ s (with recommended PTPv2 switches up to 100 ns)	100 μ s to 10 ms	< 1 μ s	< 1 μ s
Synchronization settling time	Immediate	Up to 20 s (on initial start-up)	Up to 30 min during first start, up to 2 min during restart	Immediate	Immediate
Synchronization master	Auto 1 QuantumX module	Auto oder Grandmaster-Clock	External SyncMaster, e.g. PC	External SyncMaster	External IRIG-B master
Voltage supply	< 1.5 A, looped through	-	-	-	-

Synchronization via IEEE1394b FireWire

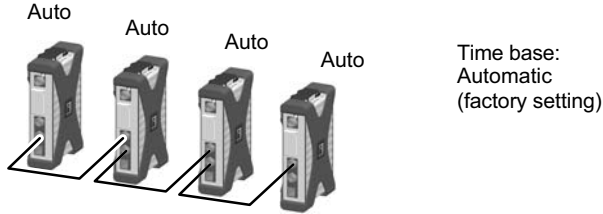

Synchronizing via CX27B (EtherCAT®)

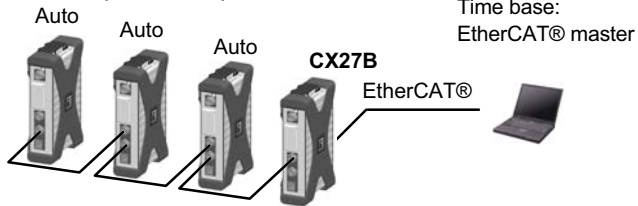

Synchronizing via Ethernet / NTP and Gateway CX27B (IEEE1394b FireWire to the modules)

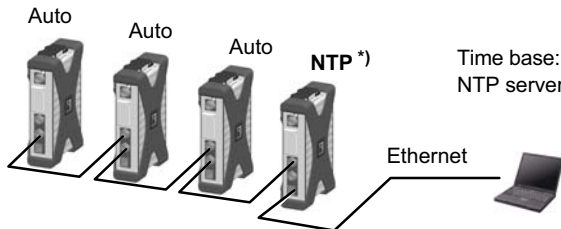

Synchronizing via Ethernet / NTP (without IEEE1394b FireWire)

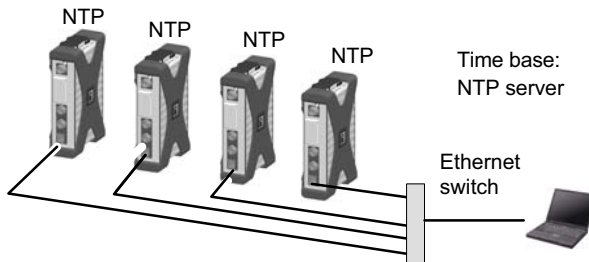

*) CX27 or the module with the highest serial number

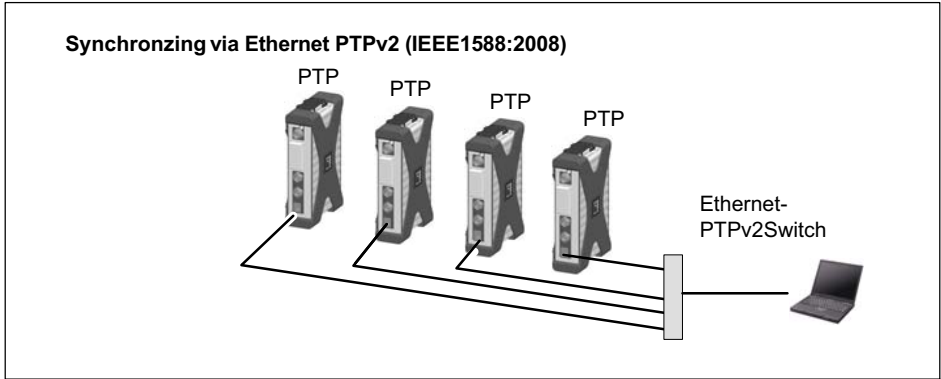
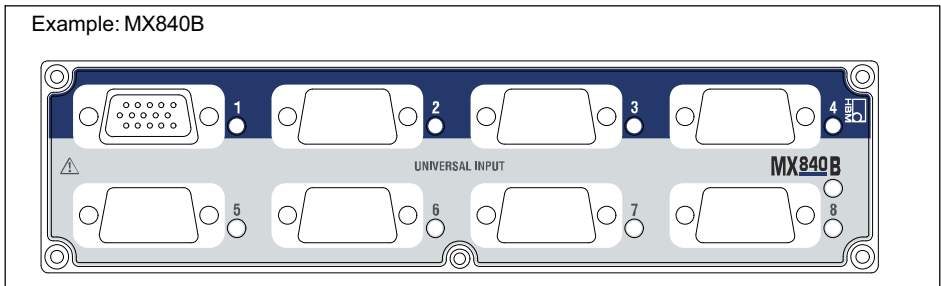

Fig. 4.1 Different methods of time synchronization

Additional information on the subject of "synchronized"

To achieve a precise reference over time, the applicable channels must be parameterized with the same filter settings. In the modules no automatic run-time correction is carried out. The filter runtimes are shown in the respective data sheet. After booting and successful synchronization, the system LED is lit green. If synchronization is disturbed, or not yet established, the system LED is lit orange.



Time format used

Basis: 1.1.2000
Time stamp: 64 bit
32 bit seconds
32 bit fractions of a second,
resolution ($1/2^{32}$)

These time stamps are appended to the measured values.

There are several synchronization methods to choose from (*also see Fig. 4.1 page 30*):

- Synchronization via IEEE1394b FireWire
- Synchronization via EtherCAT® (CX27)
- Synchronization via NTP (*Network Time Protocol*) with IEEE1394b FireWire
- Synchronization via NTP without IEEE1394b FireWire

5 Software

QuantumX is an "open" data acquisition system, and can be integrated into a great many operating, analysis and automation software packages.

The following powerful packages are available to download:

- MX Assistant: a modern and free device or system assistant that supports all the module functions
- EVIDAS: the modern software platform for measured data acquisition, visualization and analysis with Cloud connection turns the QuantumX system into an IIoT edge recorder.
- catman[®]Easy / AP / Enterprise: the powerful, professional software for acquiring measurement data from 4 up to 20,000 channels
- Drivers for LabVIEW, Visual Studio .NET, CANape, DIAdem, MATLAB, mlab, InNova etc.
- Windows device driver for IEEE1394b FireWire

5.1 MX Assistant

The HBM "QuantumX Assistant" software offers the following functions:

System:

- Create overview (modules, host PC)

Modules:

- Data rate domain adjustment (decimal, classical HBM)
- Time synchronization adjustment
- Search and configuration (e.g. TCP/IP communication), naming
- Reset to factory settings
- Read out working standard calibration data to create a certificate in PDF format
- Analysis (information, status, log file)
- Read out, save and upload to the respective module

Channels/sensors:

- Configuration (name, connection type, TEDS, semi-automatic assignment)
- Measurement
- Activate/deactivate isochronous operation via IEEE1394b FireWire

Individual signals:

- Set sampling rates and filters (type, cut-off frequency)

Measured values (scope):

- Start/stop continuous graphic measurements (time frames, trigger, zoom)
- Basic signal analysis (X/Y cursor)
- Record measurements

Functions and outputs:

- Map inputs to outputs (scaled, filtered)
- Real-time function parameterization (RMS value, addition, multiplication), torsional vibration analysis, limit value monitoring, matrix calculation, PID controller
- Map signals to CAN messages or route CAN to CAN, including adaptation of data types, and save configuration as database (*.dbc)
- Map signals to EtherCAT messages and save configuration as database (*.esi)

Sensor database

- Write/Read sensor data sheets to TEDS
- Add user-defined sensor data sheets, import CANdb (*.dbc)

5.2 catman®AP

The HBM "catman®AP" software is optimally suited for the following tasks:

- Setting the communication and measurement channels (integrated TEDS editor and extendable sensor database)

- Configuration of measurement or test tasks (channels, sampling rates, triggers, comments, interactions)
- Setting up virtual online calculated channels (algebra, FFT, logic, SG rosette evaluation, differential, integral, etc.)
- Setting up limit value or event monitoring (digital output activation, acoustic alarm, logbook entry) including Push notification
- Individual graphic representation options (strip chart, analog meter, digital or bar display, tables, 2D frequency spectrum, geographical maps, status LED, etc.)
- Signal visualization in time, frequency or angular realization
- Diverse storage options (all data, cyclic, ring buffer, long-term measurements, etc.)
- Maximum data throughput of 12 MS/s or 100 Mbyte/s
- Export of measured data in current data format (catman®BIN, Excel, ASCII, MDF, MAT, DIAdem, UFF)
- Graphical post-process analysis of recorded data, data cleansing and export to different formats.
- Automation of measurement sequences (AutoSequence and EasyScript)
- Generating reports (with graphic displays, analyses, comments)

The software package *catman*®AP consists of various modules:

- *catmanEASY* – the basic package for recording measurement and virtual channels, visualization and storing measurement data with integrated sensor database and TEDS
- *EasyRoadload* includes Ethernet drivers for Kistler RoadDyn® measuring wheels, EasyVideocam, geographical maps, importing a channel parameter list from Microsoft Excel.
- *EasyMonitoring* contain Parallel Recording Integration FTP/SFTP Client including Push notification.
- *EasyVideocam* Integration of up to 4 video cameras (generally Windows DirectShow, USB / Ethernet / FireWire)

- *EasyPlan* allows for preparatory parameterization and configuration without an amplifier connected using a wizard or tables with Microsoft EXCEL®
- *EasyScript* is based on the current VBA standard (Visual Basic for Applications) and allows users to write their own scripts for individual measurement tasks
- *EasyMath* allows mathematical post-process analysis and export of measurement data

5.3 LabVIEW® driver / library

LabVIEW is a graphical programming system from National Instruments. The acronym stands for “*Laboratory Virtual Instrumentation Engineering Workbench*”.

The main application areas for LabVIEW are in measurement, control and automation technology.

LabVIEW modules are virtual instruments (VIs) or sub-programs that are used in LabVIEW programs for convenient device control. The library components are used to initialize, open and close interfaces, to initialize and configure the modules, to make settings, and to trigger and query measurements.

The **HBM LabVIEW driver** is based on the HBM common.NET API. The installation includes some examples and extensive help.

5.4 Driver for Microsoft® Visual Studio .NET

The HBM Common API can be understood as a generic application programming interface (API), and integrates QuantumX into the powerful programming environment of Microsoft Visual Studio .NET. Programmers can use APIs to directly access almost all QuantumX device functions and use them in their own programs.

Functions such as communication connection, configuration of measurement channels, implementation of measurements and troubleshooting are components of the library.

This package can be downloaded free from hbm.com. There are application-based examples and practical documentation to help you get started quickly.

5.5 Other drivers

QuantumX is an open data acquisition system and therefore has been integrated into many software packages.

Here are some examples:

- DIAdem
- CANape
- DASyLab
- MATLAB
- Mlab
- InNova

5.6 Firmware update via Ethernet

You can easily check the firmware status of the modules and update them when necessary with the "MX Assistant" software or [catman[®]](#).

Before updating your firmware, check whether your PC software needs updating first.

We recommend checking the firmware and updating it as needed:

- If you want to use a new PC software package
- If you want to expand your system with new modules

You can also determine the firmware status of your modules using the QuantumX Assistant:

- Right-click on **the computer in the device overview** → **Details** → **System overview**

6 Mechanical

QuantumX modules are extensively tested. This includes

- the extended temperature range
- mechanical vibration with an amplitude of 50 m/s² in the frequency range 5 ... 2000 Hz in all 3 axes for 2 hours, and
- the effect of exposure to 1000-fold mechanical shock with an acceleration (half cosine) of 350 m/s² for 3 ms in all 3 axes.

The degree of protection given in the technical data indicates the suitability of the housings for various ambient conditions and also the protection of persons against potential risks when used. The letters *IP* (International Protection), which are always present in the designation, are followed by two digits. These indicate which degree of protection a housing offers against contact or foreign bodies (first digit) and moisture (second digit).

QuantumX modules are in a housing with IP20 as degree of protection.

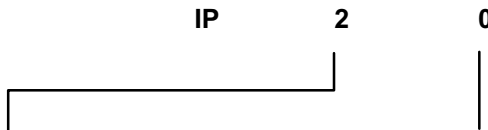

Code index	Degree of protection against contact and foreign bodies	Code index	Degree of protection against water
2	Protection against contact with fingers, protection against foreign substances with $\varnothing > 12$ mm	0	No water protection

Both housing types can be connected together with the aid of two lateral housing clips (1-CASECLIP, not included in scope of delivery). To do this, the existing lateral covers must be removed and the housing clips screwed on.

6.1 Mounting case clips on modules

The module electronics are integrated in a metal housing that is surrounded by a case protection (CASEPROT). This also serves for centering when several devices are stacked on top of each other and offers a certain degree of protection against mechanical damage.

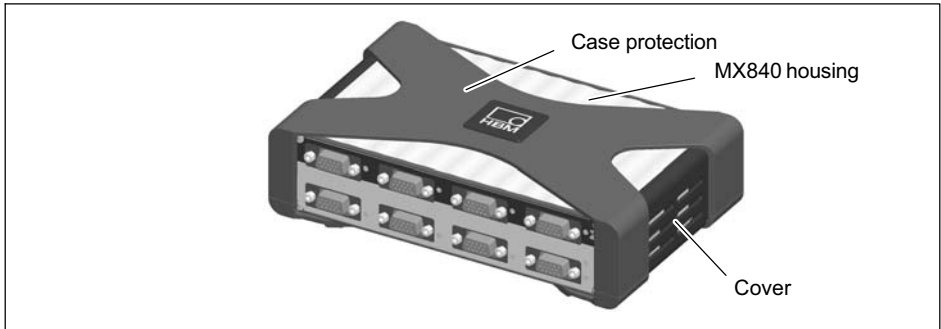

Fig. 6.1 Amplifier MX840 with case protection

The mounting of the housing clips shown in the following pictures must be implemented on both sides of the housing.

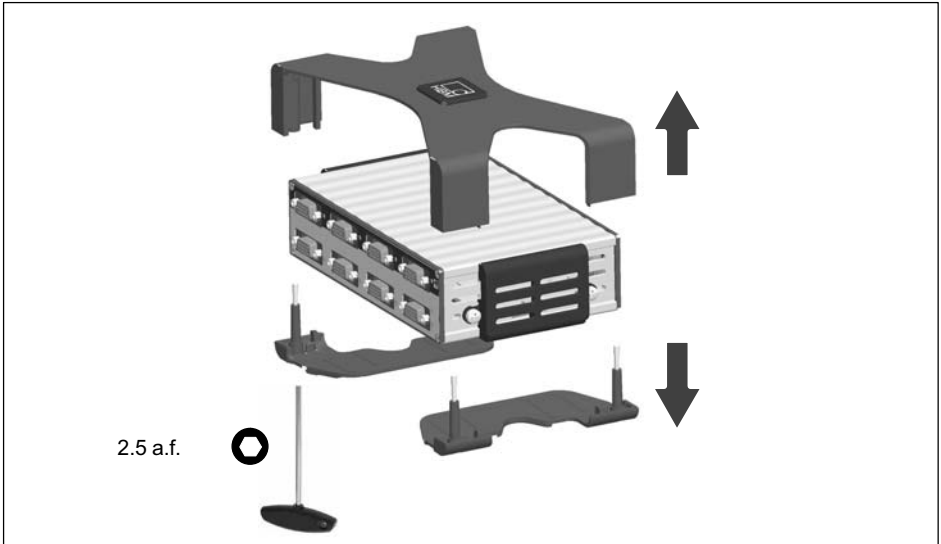

Fig. 6.2 Removing the case protection

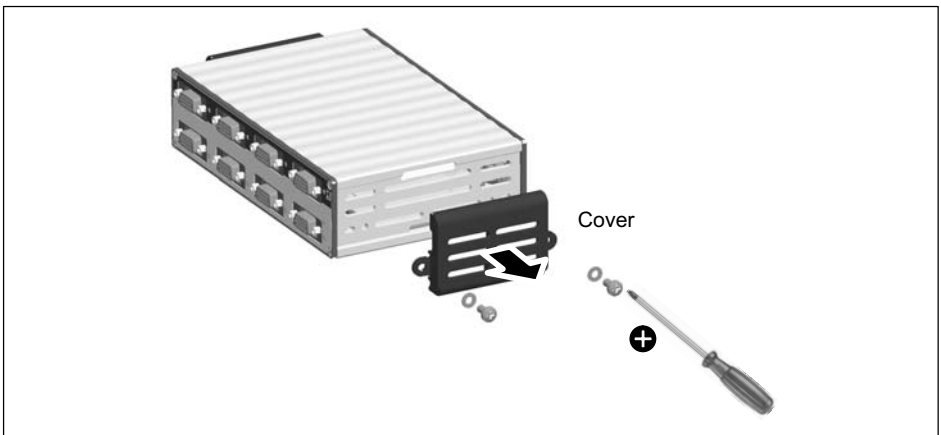

Fig. 6.3 Removing the cover

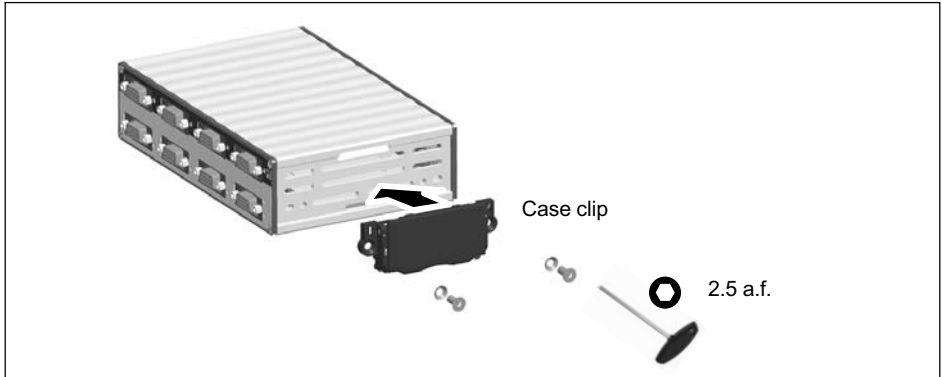

Fig. 6.4 Mounting the case clip CASECLIP

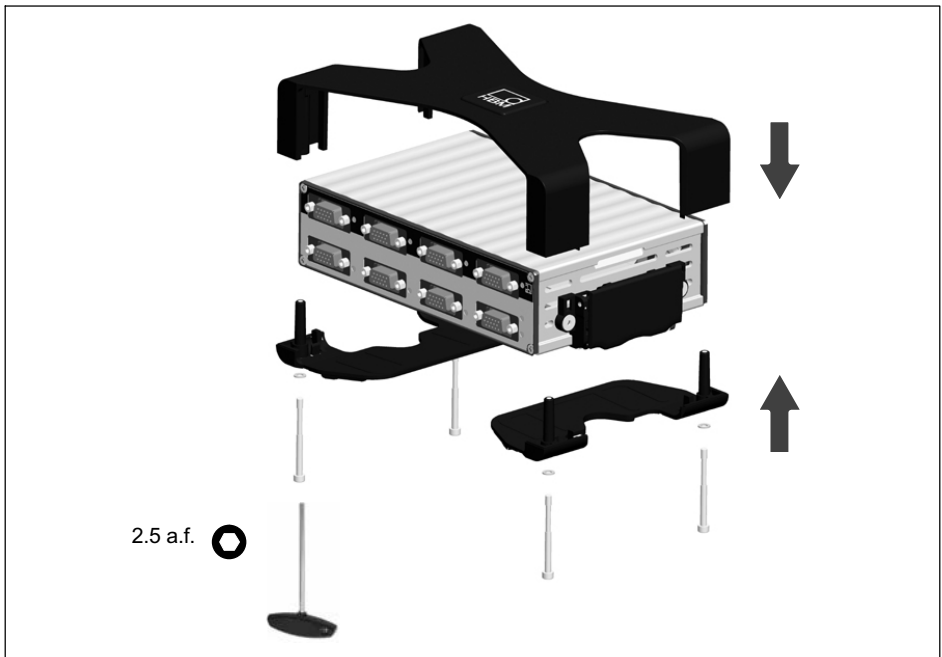

Fig. 6.5 Mounting the case protection CASEPROT

6.2 Connecting housings

The following pictures show the connection of two housings.

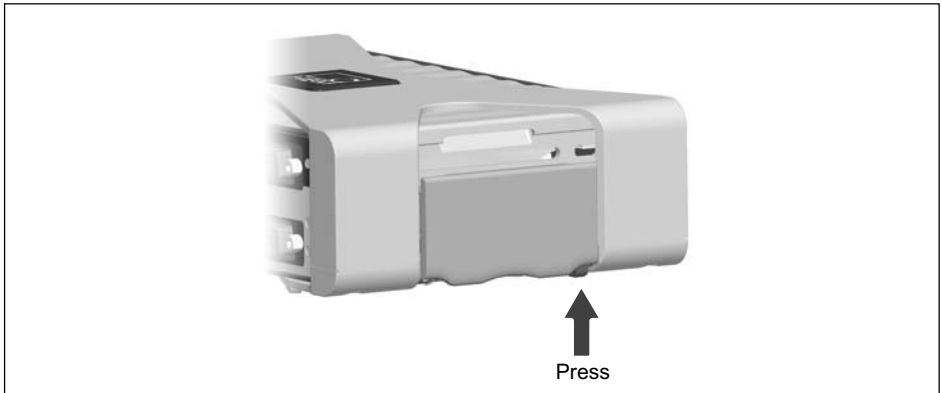

Fig. 6.6 Unclip the case clip CASECLIP

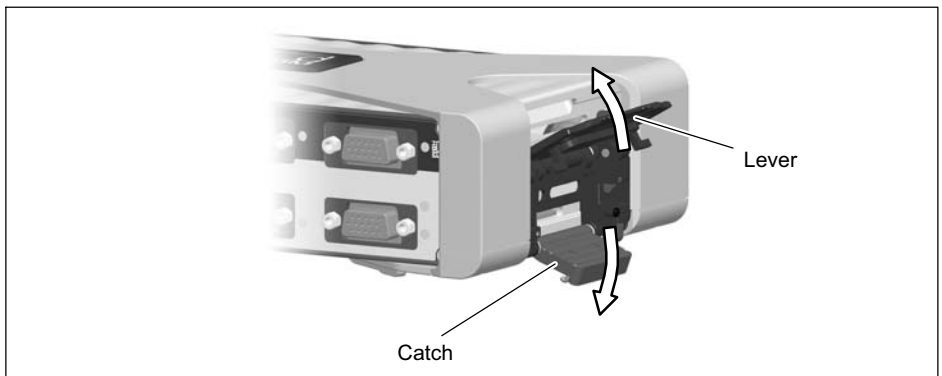

Fig. 6.7 Unclip the lever and catch



Fig. 6.8 Close the lever



Fig. 6.9 Connected housings

6.3 Mounting the housing with CASEFIT

A CASEFIT fitting panel can be used for flexible mounting of QuantumX series modules. The modules can be fastened in place with belt tensioners or case clips (CASECLIP).

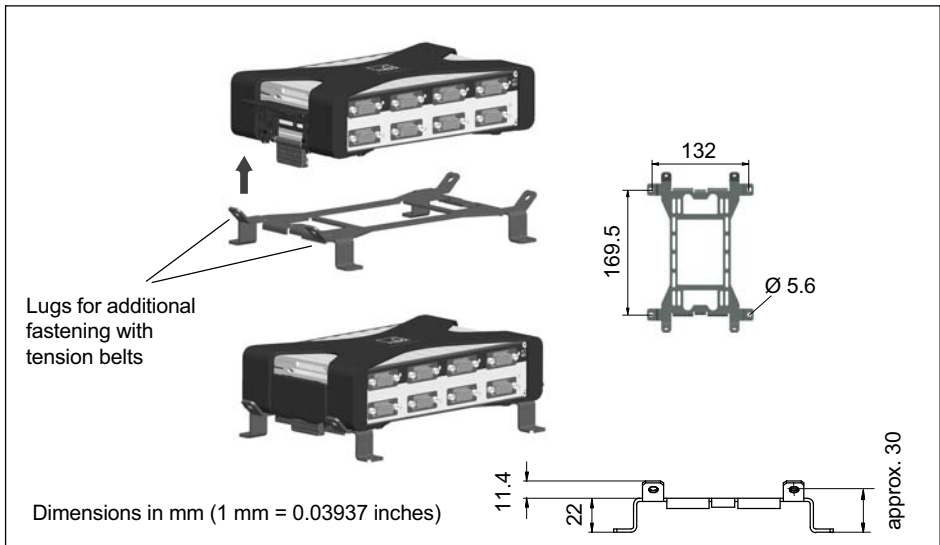

Fig. 6.10 Mounting with CASEFIT and CASECLIP

6.4 BPX001/BPX002 backplane

The use of a backplane such as BPX001 or BPX002 (RACK) allows up to 9 modules to be connected with hardly any wiring.

The backplane also has two additional FireWire interfaces for integrating distributed modules or for direct connection to a PC or data recorder. The IEEE1394b FireWire interfaces are actively interconnected.

The individual modules can also be connected via Ethernet (RJ45) through the openings on the back of the backplane. FireWire interfaces of the individual modules are actively connected to each other.

The modules can be positioned anywhere in the backplane. The backplane BPX001 is designed for wall or control cabinet installation and has drill holes

for attachment. The BPX002 backplane for rack mounting in a 19" enclosure. The BPX002 backplane is an extension of the BPX001.

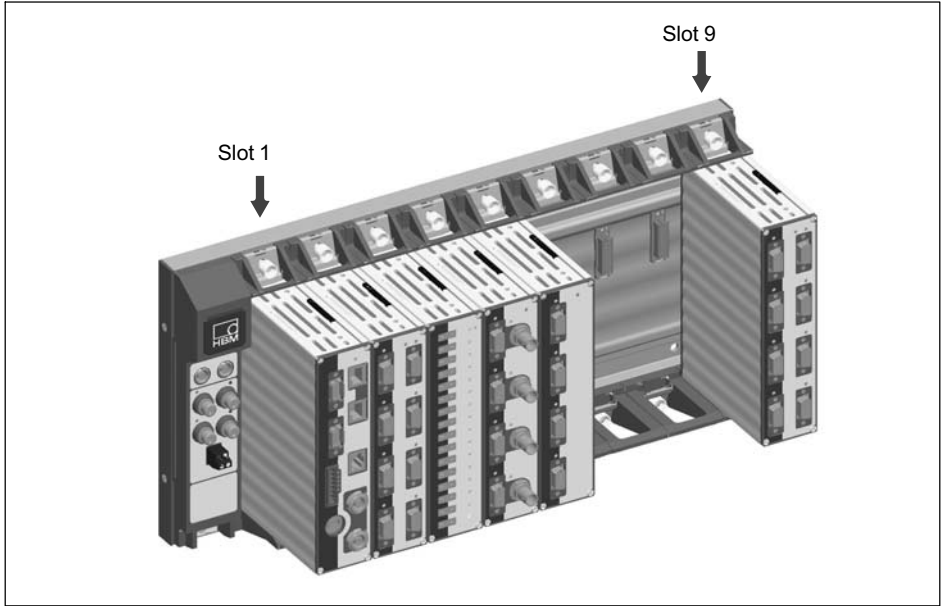

Fig. 6.11 Example of QuantumX backplane fitting

6.4.1 Connection

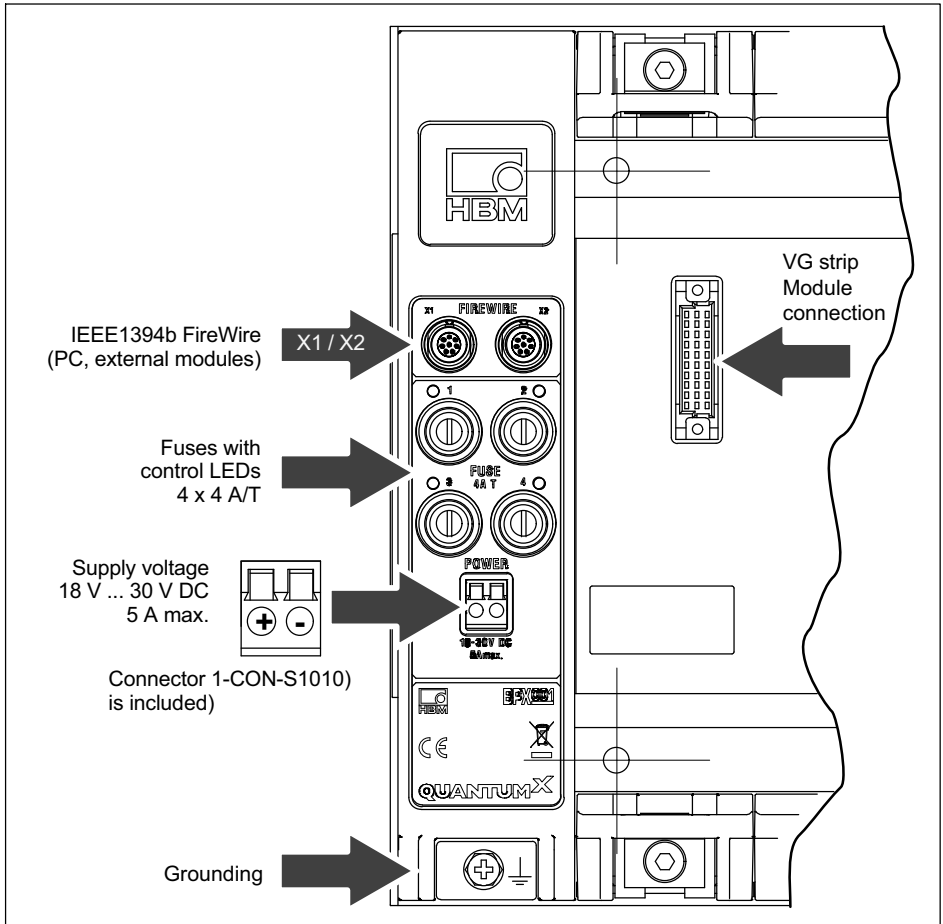

Fig. 6.12 BPX001 connections

Fuse	Protects
1	IEEE1394b FireWire X1 connection
2	IEEE1394b FireWire X2 connection

Fuse	Protects
3	Slots 1 to 4
4	Slots 5 to 9

6.4.2 Backplane BPX001

A total of 10 drill holes are provided in the backplane for wall mounting (\varnothing 6.5 mm). We recommend using the outer 4 drill holes for wall mounting.

Notice

Only use countersunk screws for fastening. Otherwise the modules cannot be mounted correctly.

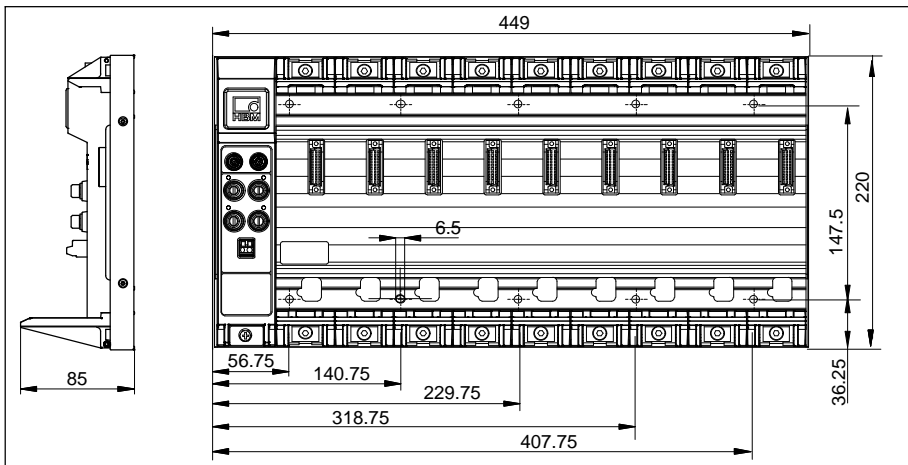

Fig. 6.13 BPX001 drilling pattern and dimensions

Note the following information when installing one or more backplanes in a control cabinet:

- When installing in a control cabinet, the temperature limits given in the technical data of the backplanes must be complied with

- Depending on the installation situation, sufficient ventilation (vertical air flow) or cooling must be provided (the maximum total output on a backplane is approx. 150 watts)
- The ventilation slots of the modules must not be covered (by cable ducts, etc.)

6.4.3 Backplane BPX002

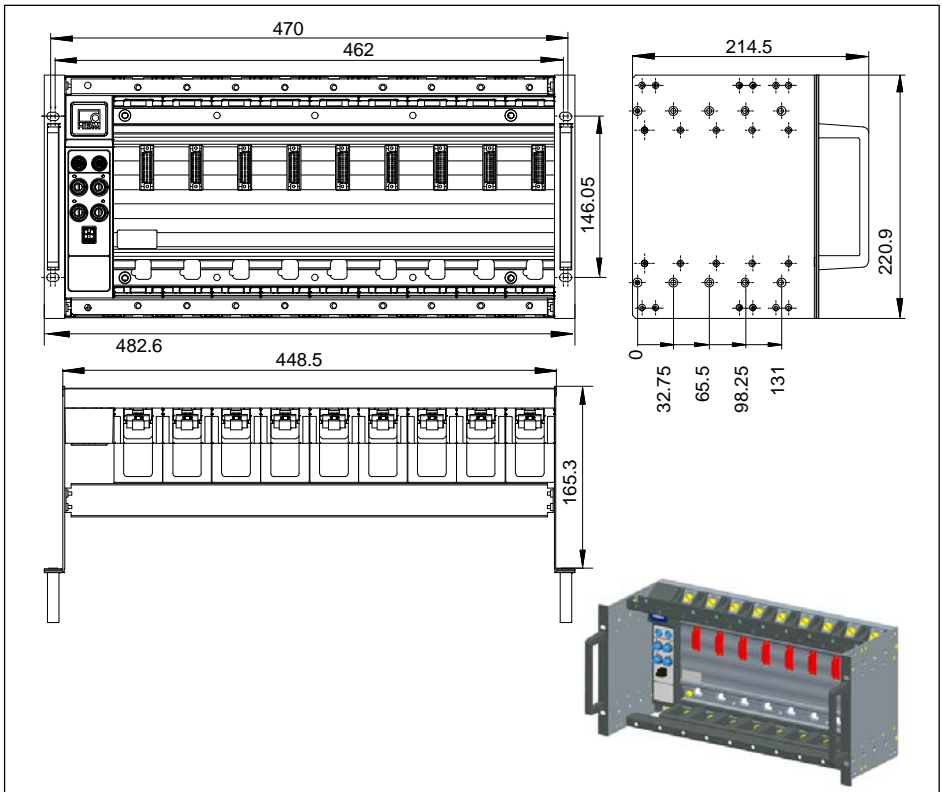

Fig. 6.14 Rackmontage BPX002

6.4.4 Mounting the modules

Tools



We recommend a T-handle Allen wrench 4x150 (4 mm across flats, length 150 mm).

Notice

The modules can only be fastened in backplanes in housings with degree of protection IP20 without case protection, case clips or lateral covers. If these are present, remove as shown in section 6.

Mounting sequence:

1. Remove the cover of the connecting plug (rear of module).

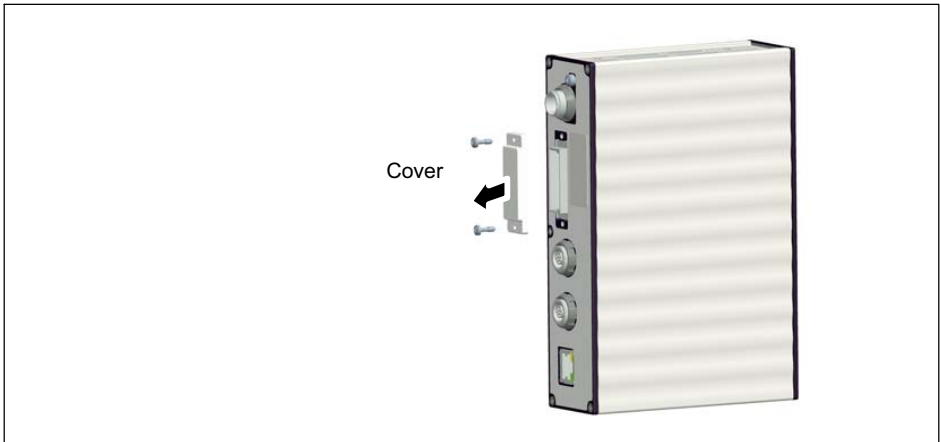

Fig. 6.15 Removing the cover

2. Unscrew the upper and lower screwed clamping glands of the backplane up to the stop (the screws are secured against falling out!).

3. Position the module vertically on the backplane and push it in carefully on the lower guide rail back up to the stop.

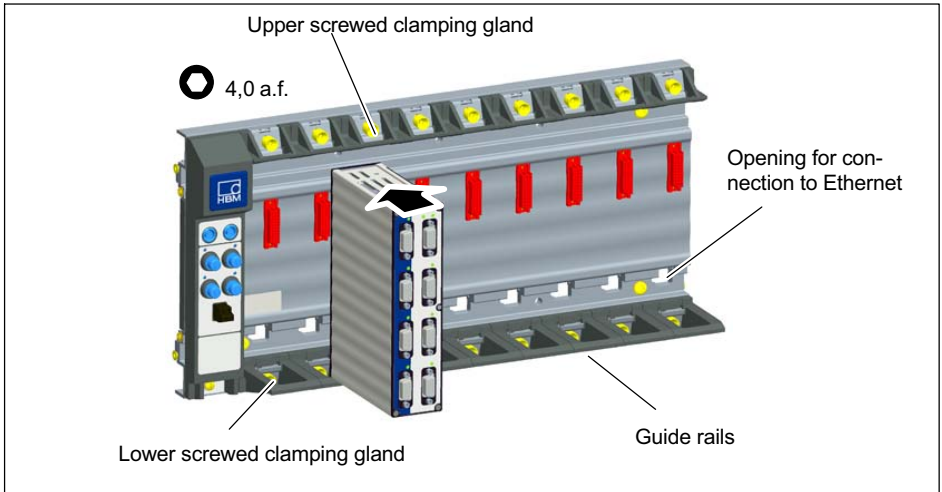

Fig. 6.16 Mounting the module

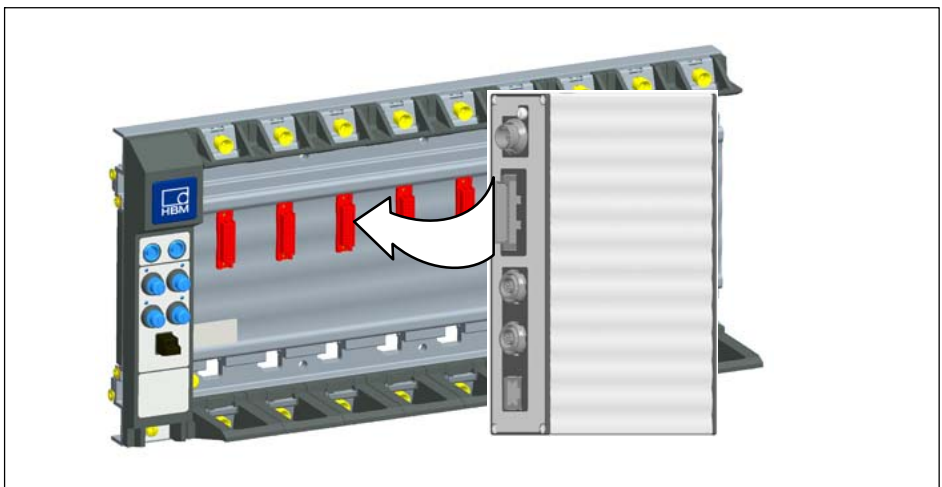

Fig. 6.17 Centering above the connection plug

4. Tighten the lower then the upper screwed clamping gland.

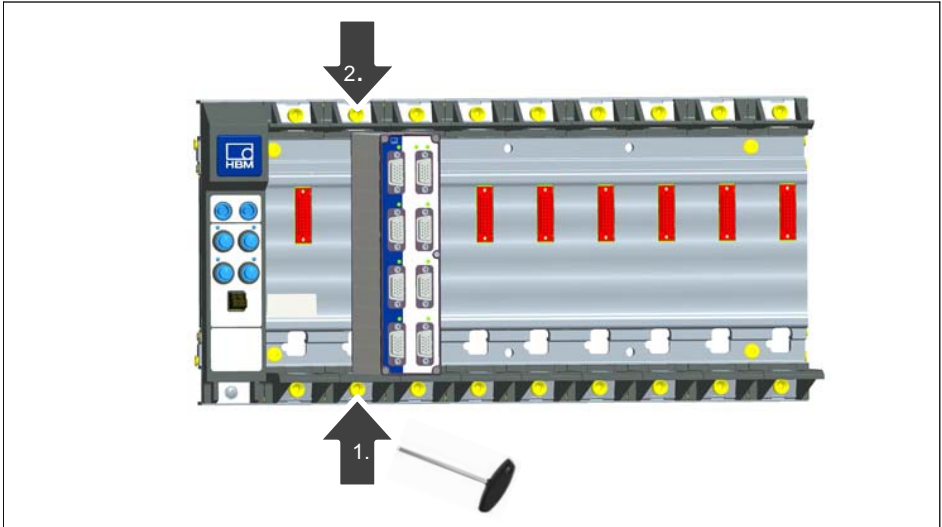

Fig. 6.18 Tightening the screwed clamping glands, sequence

6.4.5 Backplane with Ethernet connection

A central CX27B gateway enables a BPX backplane to be connected. Maximum sampling rate: 400 kS/s.

The IEEE1394b FireWire sockets on the backplane allow integration of distributed modules into the system.

The individual modules can also be connected directly via Ethernet on the back, with maximum sampling rate. In this case, no gateway is required.

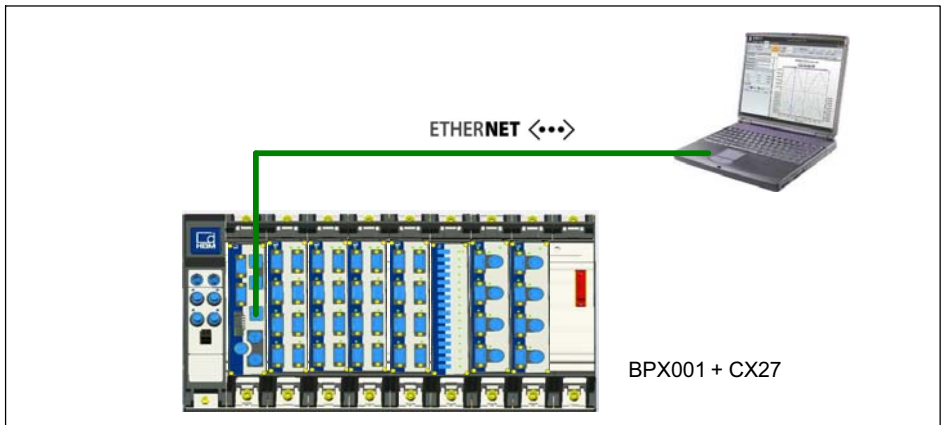

Fig. 6.19 Connecting a backplane via Ethernet

6.4.6 Backplane with IEEE1394b FireWire connection

The BPX backplane can be connected via IEEE1394b FireWire directly to a PC or data recorder.

The second IEEE1394b FireWire socket on the backplane can be used to integrate distributed modules into the system.

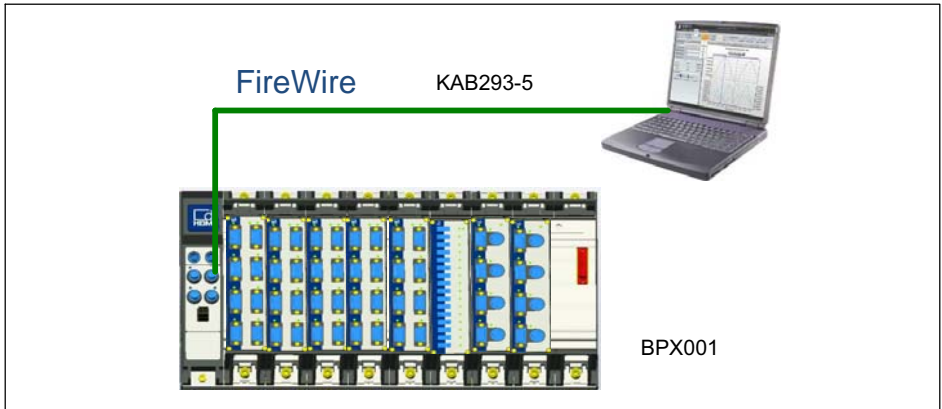

Fig. 6.20 Connecting a backplane via IEEE1394b FireWire

6.4.7 System layout with several backplanes

Multiple BPX backplanes can be synchronized via CX27 gateway modules. Connection of CX27 to CX27 via KAB272-2 or -5, via front IEEE1394b FireWire connection.

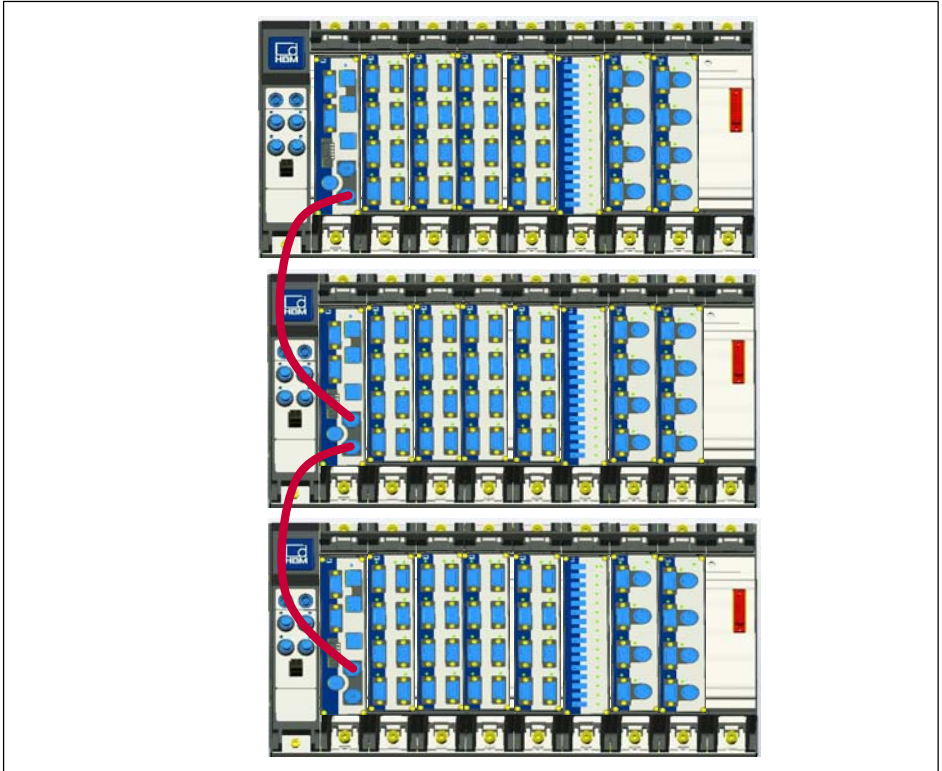

Fig. 6.21 Synchronizing multiple backplanes

7 Connecting individual QuantumX modules

7.1 Connecting the supply voltage

Connect the modules to a DC voltage of 10 V ... 30 V (24V recommended). The power consumption per device can be found in the following table.



CAUTION

The following rule of thumb applies to power distribution via FireWire:
 “An external voltage supply with the *same voltage potential* is required on every 3rd module“.

Defects in the module cannot be excluded if a supply voltage > 30 V is used. If the supply voltage drops below 10 V, the modules switch off.

We recommend installing an uninterruptible power supply (UPS) in vehicles with battery operation between battery and module to compensate for voltage drops during start procedures.

Module	Typical power consumption, including transducer excitation (watts)
MX840B	12
MX440B	10
MX410B	15
MX430B	8
MX238B	8
MX460B	9
MX471B/C	6
MX1601B	13
MX1615B/MX1616B	12
MX1609/KB/TB	6
MX809B	6

Module	Typical power consumption, including transducer excitation (watts)
CX22B-W/ CX22B	12
CX27B/C	7
MX878B	7
MX879B	7

If several modules are connected to each other via *FireWire* for time-synchronous data acquisition (see Fig. 7.4), the supply voltage can be looped through. The power pack used must be able to provide the appropriate output.

The maximum permissible current on the IEEE1394b FireWire connection cable is 1.5 A. If the chain is longer, *repeating the supply connection is mandatory*.

If several amplifiers are operated non-synchronously (see Fig. 7.3), they must be supplied separately.

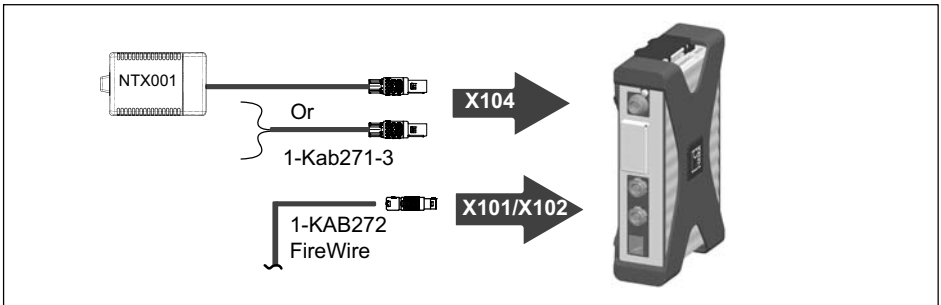

Fig. 7.1 Connecting socket for supply voltage

7.2 Connection to host PC or data recorder

7.2.1 Single Ethernet connection

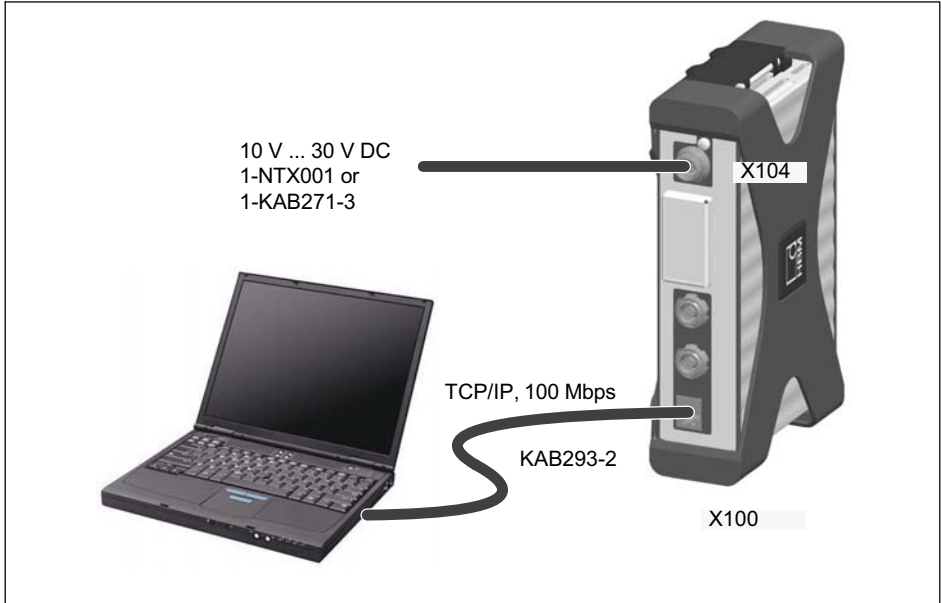

Fig. 7.2 Single Ethernet connection

Notice

You must use an Ethernet crossover cable with older computers. Newer PCs/laptops have Ethernet interfaces with autocrossing function. You can also use Ethernet patch cables for this purpose.

7.2.2 Multiple Ethernet connection with PTP synchronization

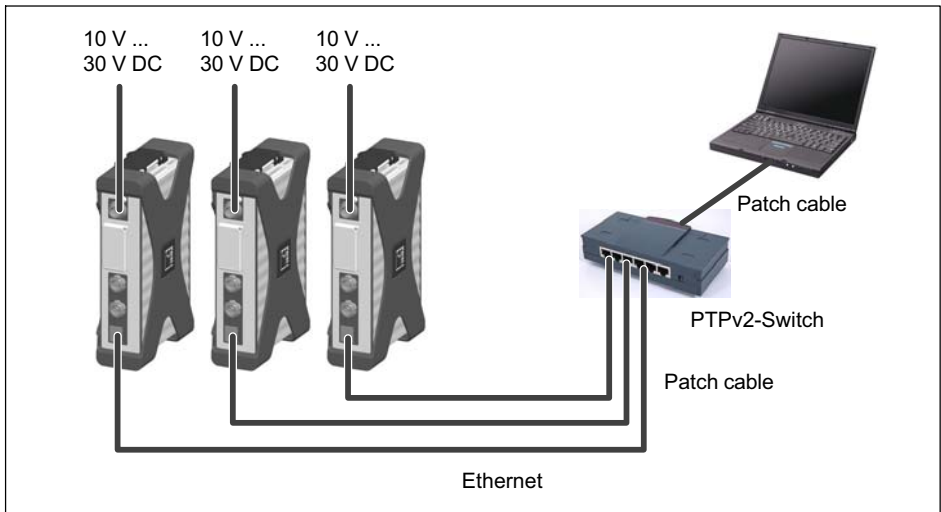

Fig. 7.3 Multiple connection via Ethernet and synchronization via PTPv2

Modules can be connected to the PC via Ethernet PTPv2-compliant switches. We recommend patch cables.

Here are some examples:

- EX23-R from HBM
- Scalance XR324-12M from Siemens
- RSP20 or MACH1000 from Hirschmann
- Ha-VIS FTS 3100-PTP from Harting
- Stratix 5400 from Rockwell

PTP Grandmaster Clock examples:

- LANTIME M600 from Meinberg
- OTMC 100 from Omicron

With the star structure displayed here, measurement data from other modules is not lost if the Ethernet cable is broken!

7.2.3 Multiple Ethernet connection and FireWire synchronization

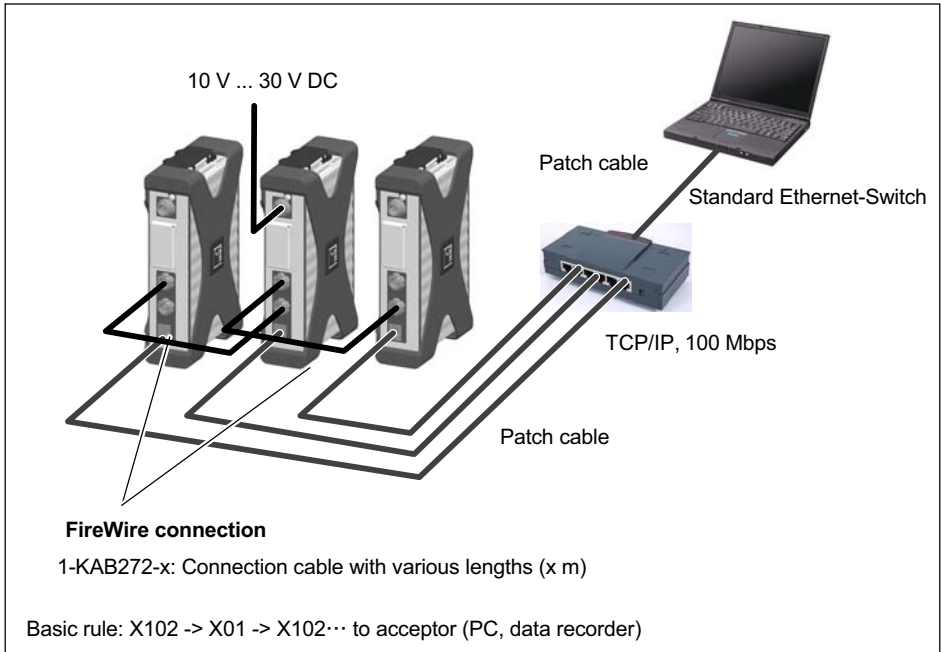

Fig. 7.4 Example of multiple connection via Ethernet with synchronization

The supply voltage for the modules is looped through FireWire in the configuration shown above (max. 1.5 A through FireWire; for power consumption of the modules, see Chapter 7).

Advantage of this connection structure: The other modules remain active if the Ethernet cable is broken.

7.2.4 Connecting one or more QuantumX modules to the PC

Modules can be connected to a standard PC via Ethernet (up to 100 m), via FireWire (electrically, up to 5 m, optically up to 300 m), or via EtherCAT.

The following must be noted for TCP/IP communication via Ethernet:

- We recommend that you retain the default setting (DHCP/APIPA), so that the software can find the modules that are in the network, or directly connected. You can, of course, also parameterize the modules with a fixed, static IP address. This also applies to the PC or notebook. Advantage: this allows notebooks in particular to be quickly and automatically integrated without re-configuration into the company network (DHCP). But direct operation between the notebook and the modules (peer-2-peer) is also very quick, using automatic addressing (APIPA).
- The Ethernet network adapter of the PC or modules can also be manually configured with a specific IP address and subnet mask, of course.

The following must be noted for direct IP-over-FireWire via FireWire connection:

- FireWire adapter addressing (e.g. expressCard/34 or PCIeexpress) at the PC or data logger end uses a previously installed Windows device driver from HBM, and cannot be modified. The modules are automatically addressed (plug-and-play and USB), and are available immediately.



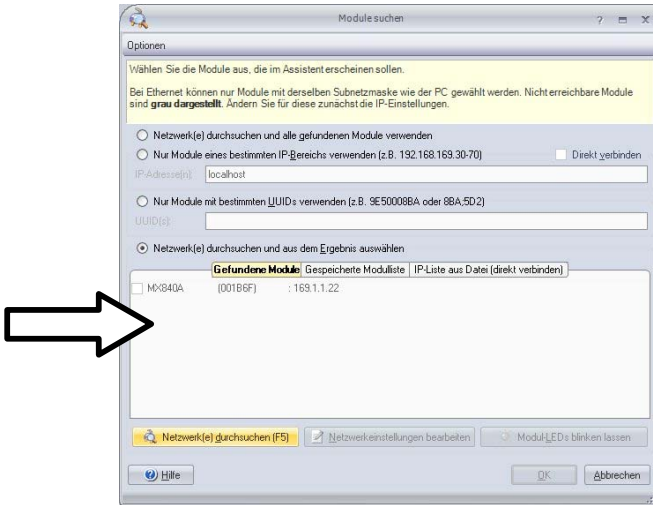

Notice

The network connection can be influenced by:

- An activated WiFi connection on your PC: Switch off this connection, if necessary, and restart the network search.
- The relevant scan ports not being enabled in the firewall settings of your PC.

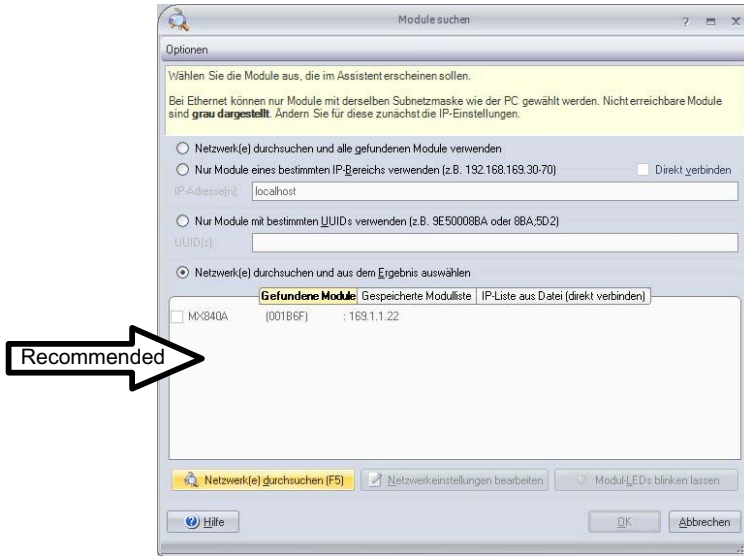

To configure the IP address of the module:

- Activate DHCP/APIPA for automatic configuration. Please set any PC directly connected to QuantumX to DHCP as well.
- Manual configuration: Deactivate DHCP and enter the same subnet mask address as used with your PC. Change the IP address of your module so that it permits communication (see example below)

Example:

Setting the IP address manually – module side

Settings	IP address	Subnet mask
Module before	169.1.1.22	255.255.255.0
PC / notebook	172.21.108.51	255.255.248.0
Module after	172.21.108.1	255.255.248.0

The first *three* digit groups of the PC and module IP addresses should be the same.

The subnet mask address digit groups must be identical in the module and PC!

Automatic configuration

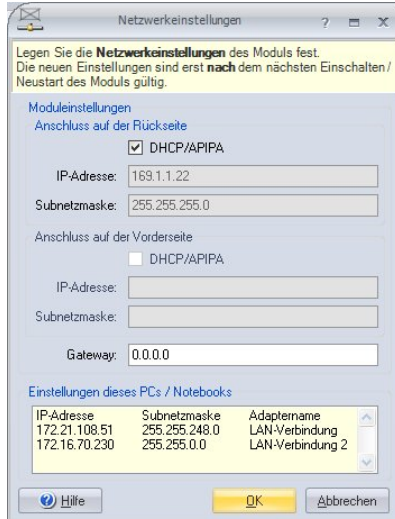

Manual configuration

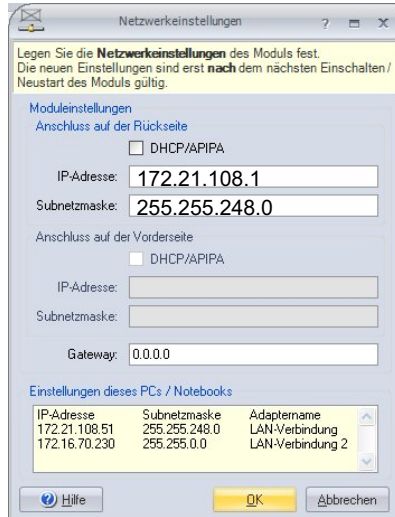

Fig. 7.5 Example of settings for a direct connection

Ethernet settings: adjust the IP address of your PC

If you want to operate the modules with a fixed, static IP address, you should use the "Alternative Configuration" (fixed IP address and subnet mask, user-defined) in the Ethernet adapter properties under TCP/IP the "Alternative Configuration" in the TCP/IP properties (fixed IP address and subnet mask, user-defined)!

Edit the PCs settings as follows:

- Open the network connections (Start/Settings/Network connections).
- Mark your LAN connection with a right-click and select "**Properties**" in the context menu.
- Select the "**General**" tab and under "**This connection uses the following items**" mark Internet (TCP/IP). Click on the "**Properties**" button.

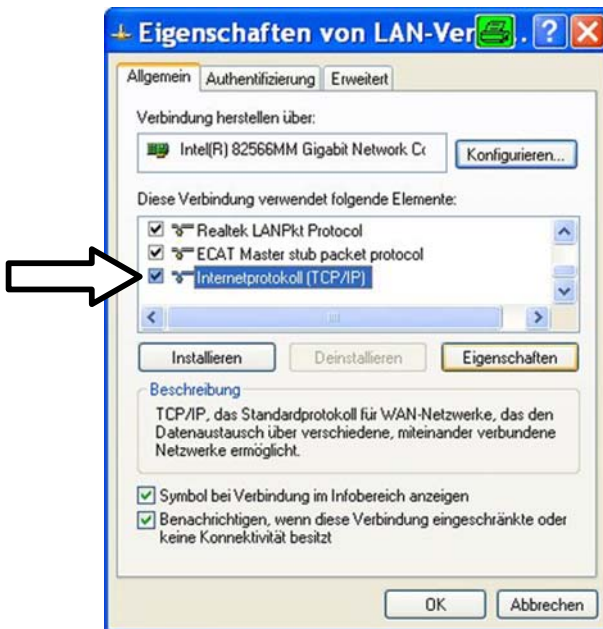

- On the "**Alternate Configuration**" tab, select the "**User-defined**" option and enter your data in the "**IP address**" and "**Subnet mask**" lines.

Example:
Setting the IP address manually – PC side

Settings	IP address	Subnet mask
Module before	169.1.1.22	255.255.255.0
PC / notebook before	172.21.108.51	255.255.248.0
PC / notebook after	169.1.1.1	255.255.255.0

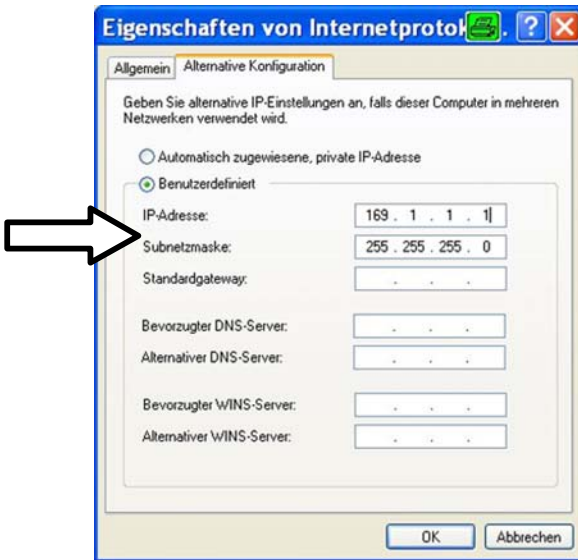

- Confirm twice with “**OK**”.

In future your computer will use the “**Alternative Configuration**” for the direct connection.

Integrating modules in an Ethernet network

- Activate the DHCP checkbox and click on “**OK**”. The following confirmation window then appears:

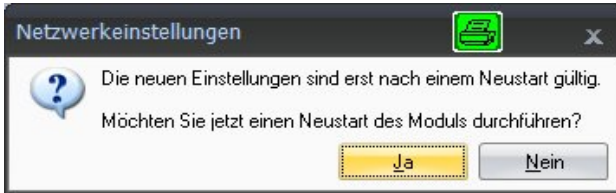

- Confirm the settings with the “**Yes**” button. The module will then be restarted with the current settings.

Notice

Please note that with the Ethernet setting DHCP/APIPA, the DHCP server requires a certain amount of time to assign an IP address to the QuantumX module. After connecting the hardware to the network or PC, wait about 30 seconds before starting CATMAN. Otherwise the device may not be found.

7.2.5 Firmware update via Ethernet

We recommend that the firmware and software used to operate QuantumX are always kept up to date.

- Download the latest firmware from the HBM website. If you do not work with catman[®], please download the QuantumX software package from the HBM website.

Please save the firmware under ...\\HBM\\catmanEasy\\Firmware\\QuantumX-B, or on C:\\Temp.

- Start catman[®], scan the network for modules and carry out the recommended firmware update. catman comes with the firmware included. This is usually stored under:
C:\\Program Files\\HBM\\catman\\Firmware\\QuantumX-B

If you do not work with catman[®], please install the free MX Assistant, connect to the modules, and use it to perform the update. If the modules have a firmware version < 2.21, you should install the QuantumX Firmware Updater tool, and use it to bring all the modules up to date. From firmware

version > 4.0, a firmware update can also be performed with the MX Assistant, or with catman.

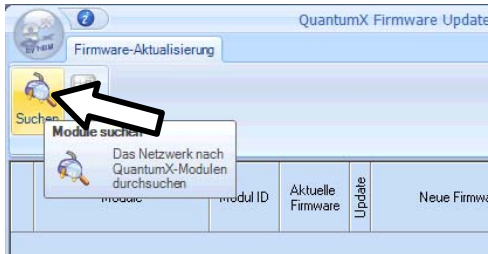

Notice

You can update the firmware of the modules directly via Ethernet, or via the CX27 gateway. You must never disconnect the data link while the update process is running.

7.2.6 Connection via FireWire (IEEE 1394b)

General information

- Baud rate of 400 MBaud (approx. 50 MByte/s)
- Asynchronous (all nodes) or isochronous (in real time) data transmission
- Data synchronization
- Supply voltage via FireWire connection cable (max. 1.5 A)

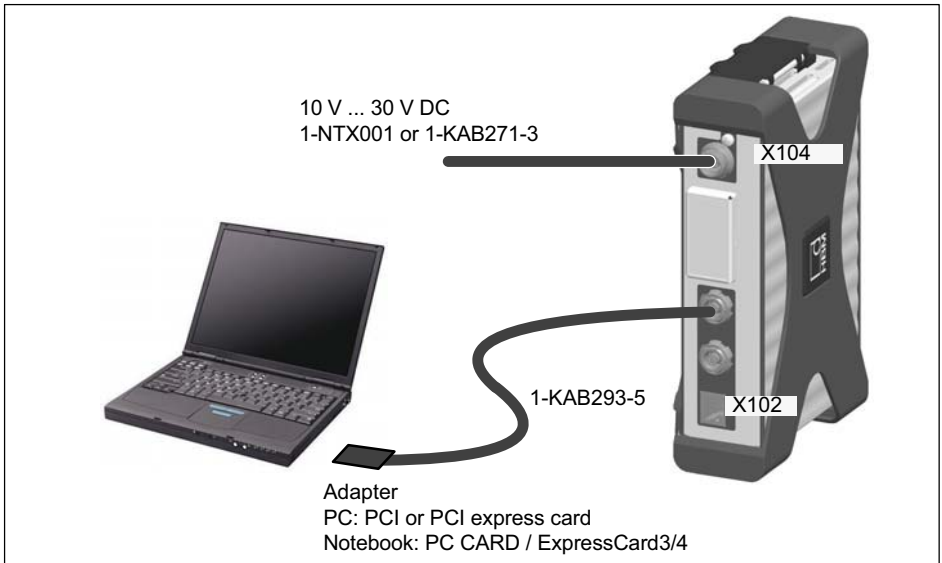

Fig. 7.6 Single FireWire connection

Notice

Please check in advance whether a firmware or software update is required. Software/firmware downloads can be found on the HBM website: www.hbm.-com/downloads

7.2.7 Setting up FireWire 1394b on the PC

- Integrate the FireWire PC adapter into your computer.
- Start the Wizard provided by HBM to install the PC-FireWire driver. The Wizard is part of the QuantumX system software package or catman. But you can also install the Wizard manually from the directory. It is usually stored under C:\Programs\HBM\FireWire\1394bus_installwizard.exe.

Notice

For troubleshooting you can switch to the original FireWire driver with "t1394bus_installwizard.exe". After the driver is installed you will find it on your hard disk.



Notice

If no modules are found via FireWire this may be caused by one of the following reasons:

- *The modules have not been properly registered. Click on the FireWire driver in the systray, check the driver after the modules and reinstall it if necessary (hbm1394.sys).*
- *Check all connections between modules.*

7.2.8 Multiple FireWire connection

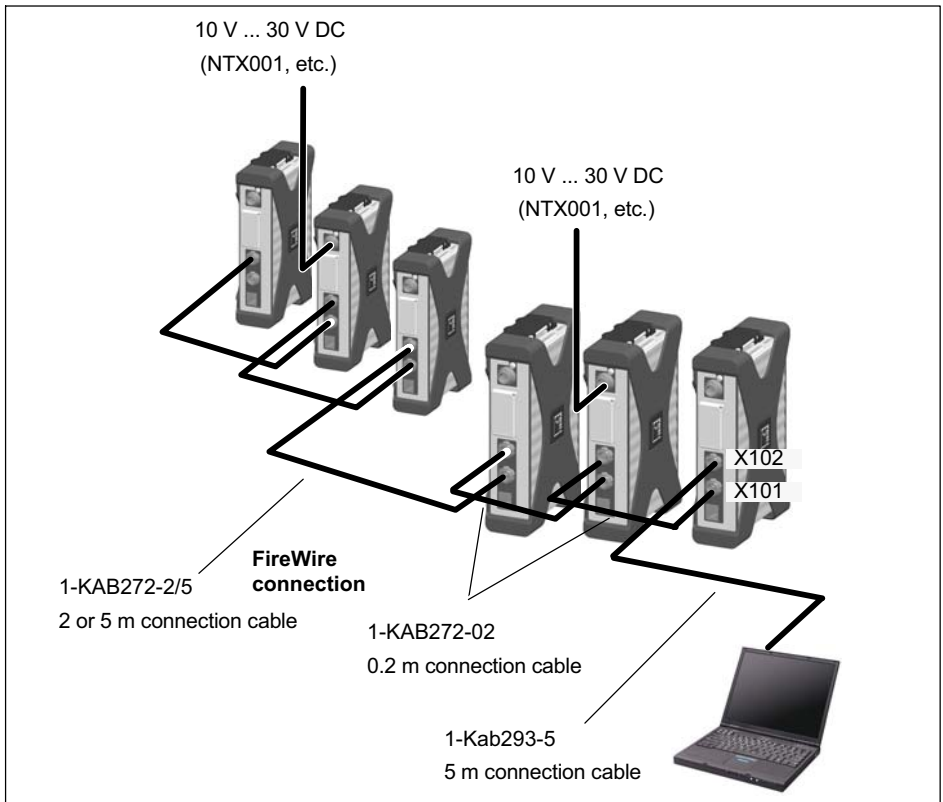

Fig. 7.7 Example of multiple connection via FireWire with synchronization

Data is transferred, modules are synchronized in timing and voltage is supplied via the FireWire connections. You can connect a maximum of 12 modules in series with each other.

Notice

Different voltage sources must have the same reference potential and should be within the same voltage range. Drops in voltage will occur due to line resistances and internal protective circuits. The last module of the chain should therefore receive a considerably lower supply voltage. Make certain that at least 10 V is still applied to the last module.

7.2.9 Layout with data recorder CX22B-W

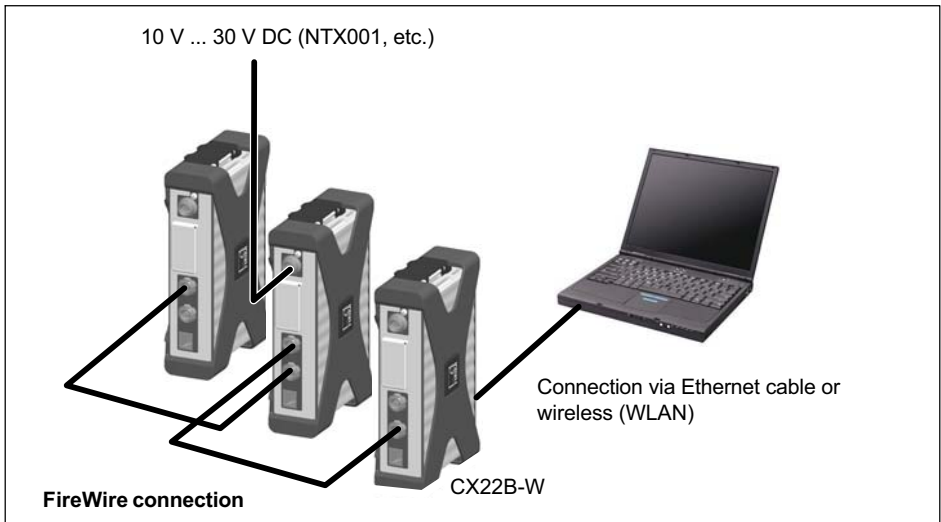

Fig. 7.8 Layout with CX22-W

7.2.10 Output measurement signals to CAN bus (MX840B)

The MX840B amplifier allows channels 2-8 to output to the CANbus (channel 1). This mode is configured entirely in the MX Assistant.



Fig. 7.9 Output to CAN bus (MX840A, connection 1)

7.2.11 Output measurement signals to CAN bus (MX471B)

The MX471B module allows measurement signals, or the signals calculated in real time, to be output to the CAN Bus. This gateway mode is typically used in test benches or in mobile measuring mode, for connection to a central CAN-based data logger.

This mode is configured entirely in the MX Assistant software. The signals to be transmitted must be parameterized isochronously (in real time), and then assigned to the relevant CAN port. The parameterization is permanently stored in the modules (EEPROM). To simplify integration at the opposite end (e.g. logger/test bench), the MX Assistant can generate a CAN database of signals (*.dbc).

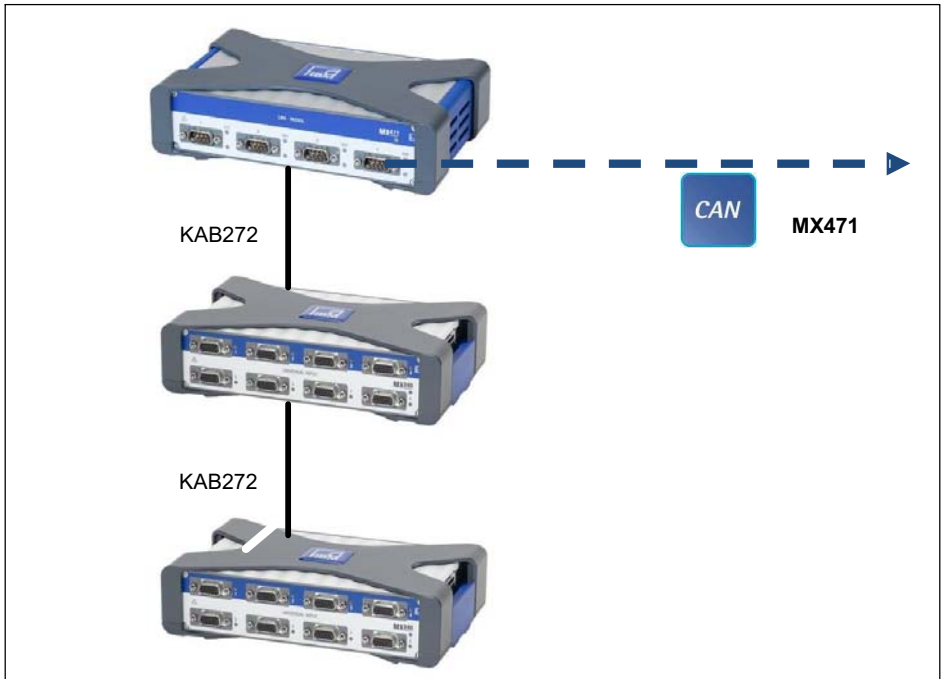

Fig. 7.10 Output to CAN bus (MX471, every connection)

7.2.12 Output of signals with standardized voltage in real time (MX878B or MX879B)

It is very easy to integrate QuantumX via the globally standardized interface of a normalized voltage (± 10 V), particularly in a test bench environment. MX878B or MX879B modules for distributed use serve this purpose. These modules also allow on-board different input channel calculations, such as matrix calculation for compensation of parasitic effects in multi-component transducers, ADD-MUL, PID controls or limit value switches.

This mode is configured using the catman[®] or MX Assistant software. All the modules must be connected via FireWire, and the signals to be transmitted (analog, digital rotary encoder or digital CAN Bus signals) must be parameterized isochronously (real-time operation) and then assigned to the relevant analog voltage output. The parameterization is permanently stored in the modules

(EEPROM). The maximum measuring rate is limited to 5 kHz. The mapping of harmonic signals up to approx. 500 Hz is excellent. Maximum bandwidths and ultra-short latency times are achieved with MX410B.

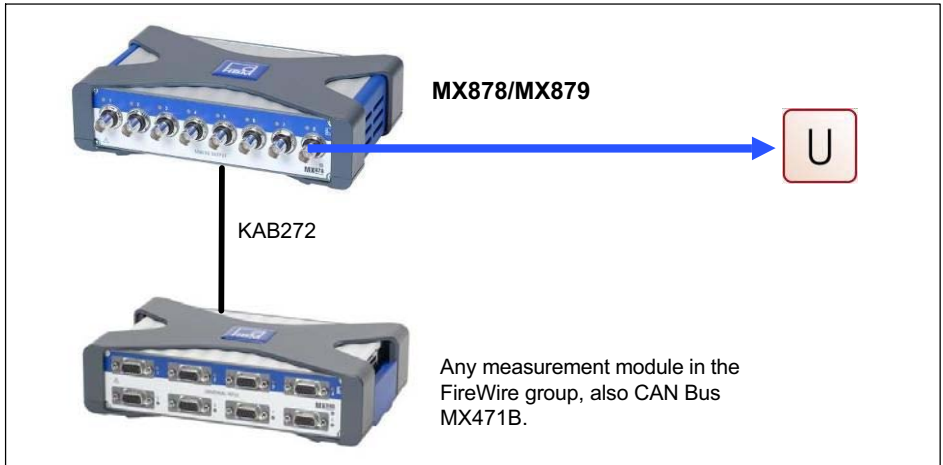

Fig. 7.11 Analog output in real time

7.2.13 Output signals in real time via EtherCAT® or PROFINET IRT and in parallel via Ethernet

Each source in a QuantumX system is distributed into two signals, to which different data rate and filtering parameters can be assigned.

For example, the *first* signal of an input channel with a high data rate, e.g. acceleration sensor with 100 kS/sec measured values and deactivated filter for analysis while the *second* signal with 5 kS/sec can be output via EtherCAT®.

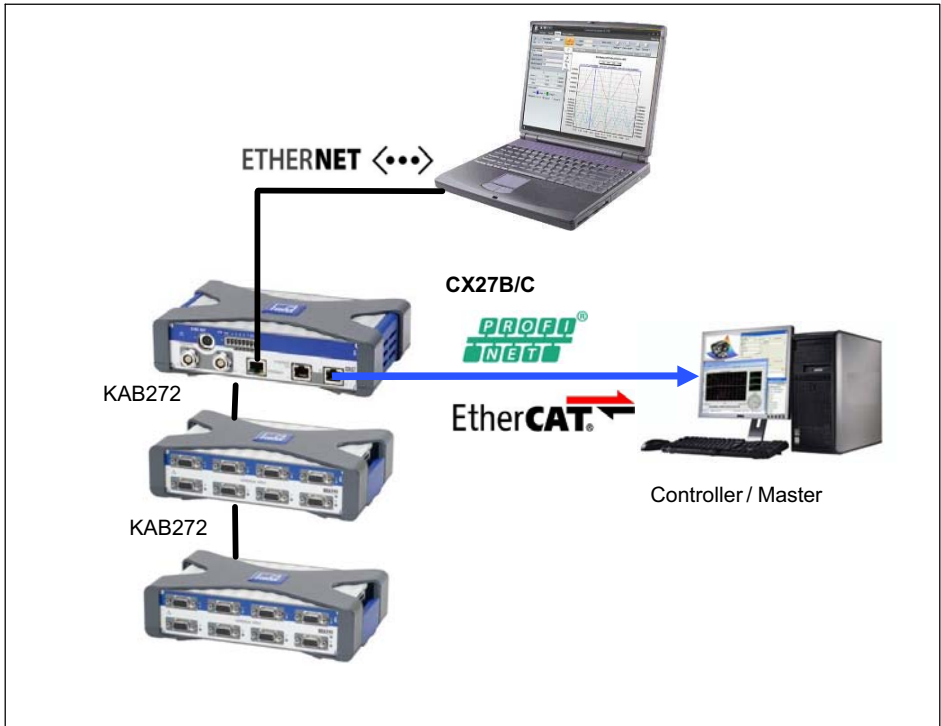

Fig. 7.12 Output in real time via the fieldbus and in parallel via Ethernet

7.2.14 QuantumX in the FireWire group

The number of modules connected in series (daisy chain) is limited to 12. If you want to connect more modules (maximum 24), you must use hubs. Hubs are devices that connect network chains together in star configurations.

A hop is the transition from one module to another (this means $n-1$ hops for n QuantumX modules in a chain).

Depending on the connection situation, 1 to 2 hops are counted in one hub.

To count the total number of hops, the longest chain to the data sink must be counted (worst case).

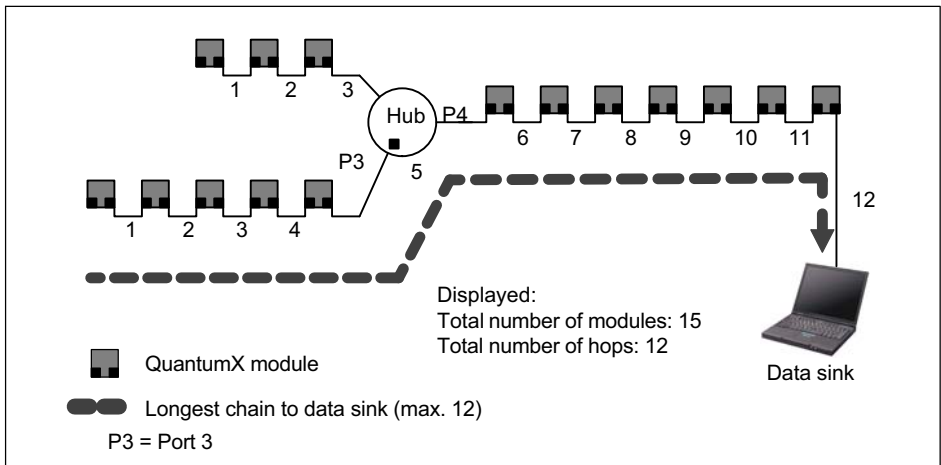

Fig. 7.13 Example of a star topology with two chains and one hub

Notice

It is not possible to install additional modules in the QuantumX system during operation (not hot-pluggable). If you would like to add new modules to the group, please disconnect the power from the modules.

8 Modules and transducers

8.1 General information

8.1.1 Shielding design

Sources of interference can cause electromagnetic fields which can induce interference voltages inductively or capacitively via the connection cable and device housing in the measurement circuit and therefore interfere with the device function. It must be ensured that the devices used in the system also do not transmit any electromagnetic interference. Electromagnetic compatibility (EMC), which encompasses both the required electromagnetic interference immunity (EMI) and the permissible electromagnetic interference emissions (EME), has become increasingly important over the years.

The HBM Greenline shielding design

The measuring chain is completely enclosed by a Faraday cage by appropriate routing of the cable shield. The cable shield is extensively connected with the transducer housing and is routed via the conductive plug to the amplifier housing. The effect of electromagnetic interference is significantly reduced by these measures.

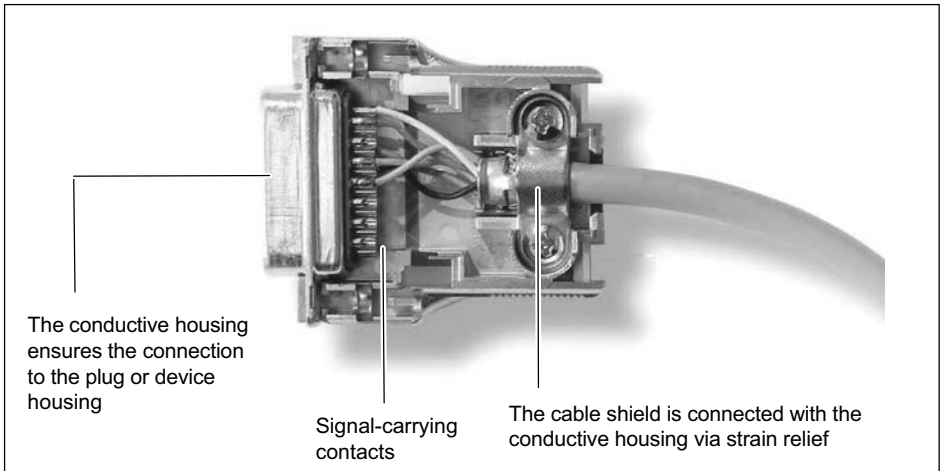

Fig. 8.1 Routing of the cable shield on the plug

Notice

All parts of the measurement chain (including all cable connection points such as plugs and couplings) must be surrounded by a closed EMC-proof shield. Shield junctions must represent a full contact, closed and low-impedance connection. This is the case for original HBM plug connections.

Ground connection and grounding

As the signal ground and shielding are separated in EMC-compliant cabling, the shielding can be connected at more than one point to the ground, i.e. via the transducer (metal housing) and the amplifier (housing is connected to the grounded conductor).

If there are differences in potential in the measuring system, a potential compensating line must be laid (reference value: highly flexible stranded wire, wire cross section 10mm^2). Signal and data leads must be set up physically separated from current-carrying power lines. Ideally, cable ducts made of sheet metal with an internal partition should be used. Signal ground, ground and shielding must be laid out as separated as possible.

In order to minimize the effect of electromagnetic interference and differences in potential, the signal ground and ground (or shielding) are designed to be physically separate in the HBM devices. The grounded supply connector or a separate ground potential lead should serve as the ground connection, as is the case for potential compensation in buildings, for example. The ground cable should not be connected to a radiator body, water pipe or similar objects.

8.1.2 Active transducer connection

Some modules can supply active transducers with a supply voltage of 5...24 V.

When using the adjustable transducer excitation, electrical isolation from the supply voltage of the amplifier is not required.

The maximum permissible power consumption is 700 mW per channel, but no more than 2 W total. If the power consumption is more than 700 mW on one channel, the transducer excitation of this channel will switch off. If the power consumption exceeds a total of 2 W, the device may switch off.

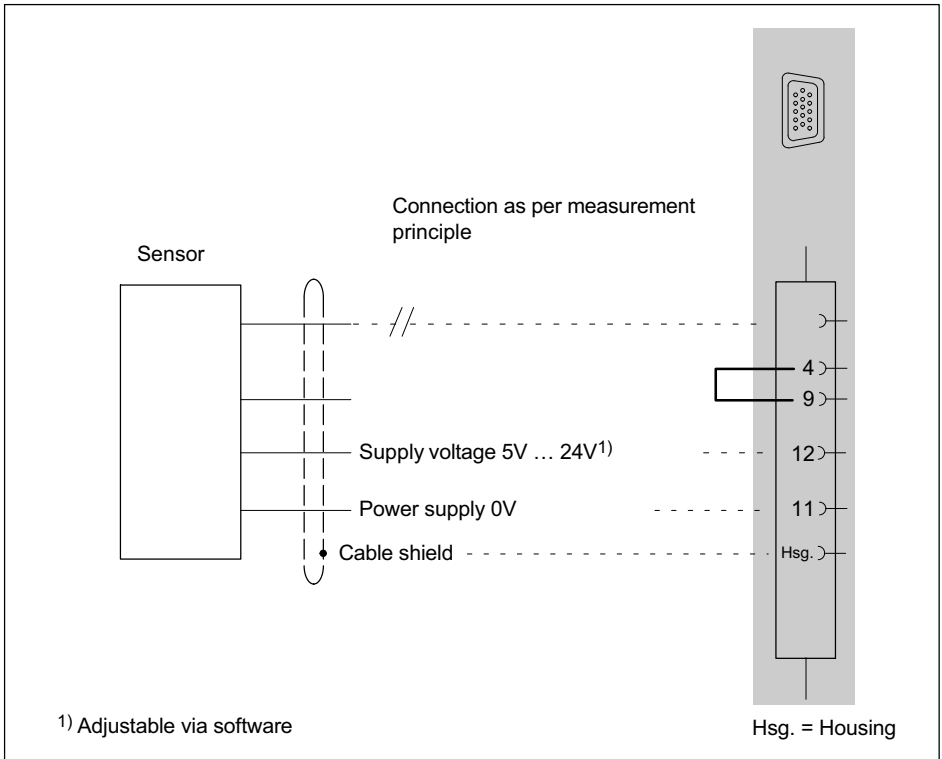

CAUTION

Check the correct voltage setting when connecting a sensor. Too high a voltage can destroy the sensor. The sensor supply is switched off in condition at the time of delivery.

8.1.3 TEDS

TEDS stands for "Transducer Electronic Data Sheet" and refers to the electronic data sheet of a transducer or sensor that is stored in a small electronic chip or appropriate module which is permanently connected to the device.

In addition, valuable metadata such as calibration data is provided, which gives important information for the traceability of measurements or tests. The electronic data sheet can be located in the transducer housing, in the inseparable cable or connector plug.

The function and working method of TEDS are defined in Standard IEEE1451.4.

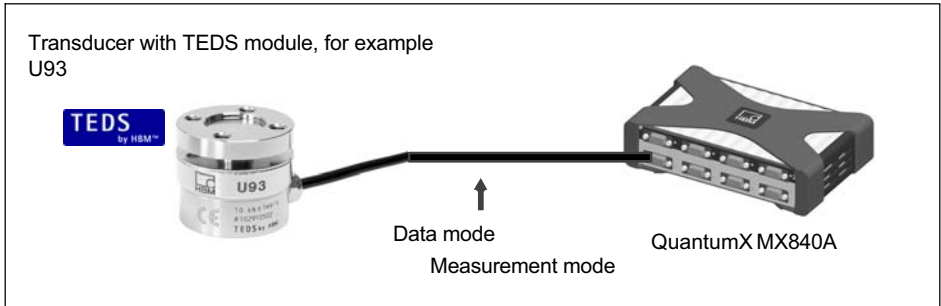

Transducer information stored in the TEDS data memory:

- the physical unit of the measured quantity (N for force, for example) and its measuring range
- the unit of the electrical output signal (mV/V for bridge transducers, for example)
- the linear characteristics as the relation between the measured quantity and the electrical signal
- if applicable, the requisite excitation and electrical power supply of the transducer

Additional information, that could be read using appropriate software, for example:

- transducer manufacturer, type, serial number etc.
- calibration date, recalibration interval, calibrator's initials, etc.

The amplifiers in the QuantumX series are capable of reading the transducer information stored in the data sheet and automatically converting it into amplifier settings to enable rapid and safe measurement operation.

The electronic data sheet is read automatically as soon as the transducer is connected to the device. The electrical bridge between two pins in the plug serves as the "transducer identification". The amplifier switches automatically to the configured measurement mode after the digital identification mode.

TEDS data can also be read with a software command, for example with cat-man[®]AP.

All TEDS data can be read and edited with the TEDS Editor, see section 3.6.

QuantumX supports several options for reading and writing TEDS data:

- It is possible to access a TEDS module via two separate cable wires ("one-wire circuit") or retrofit TEDS in the transducer connector.
- Amplifiers with direct connection of IEPE transducers support TEDS Version 1.0.
- A special TEDS module is integrated in some HBM transducers. It can transmit TEDS data via the feedback line of a sensor (patented "zero-wire circuit").
The amplifier switches to the measurement mode after the digital communication (data mode). These transducers include the force transducer U93 for example.
- Thermocouple amplifiers with RFID chips on the transducer connector support the TEDS technology, for example to automatically transmit the measuring point or additional calibration data to the amplifier after connection.

The data sheet of each amplifier includes further specifications with regards to TEDS, e.g. the maximum possible cable length to the transducer. If TEDS is not used, the possible cable length can be significantly longer.

Retrofitting TEDS in transducer connectors

The IEEE standard 1451.4 defines a generally acknowledged process with which sensors can be identified. The sensor is identified by the respective data sheet which is stored in electronic format in the sensor, cable or plug on a 1-wire EEPROM (TEDS - Transducer Electronic Data Sheet). The amplifier communicates with this EEPROM via the serial 1-wire interface, reads the data sheet and makes the corresponding amplifier settings.

The following figure shows the retrofitting of TEDS in a plug. The bridge between Pin 4 and Pin 9 is used for plug identification of the transducer. It starts automatic reading of the TEDS.

HBM recommends the TEDS-module (1-Wire® EEPROM) DS24B33 from Dallas Maxim. HBM offers a package with 10 TEDS: order no. :1-TEDS-PAK

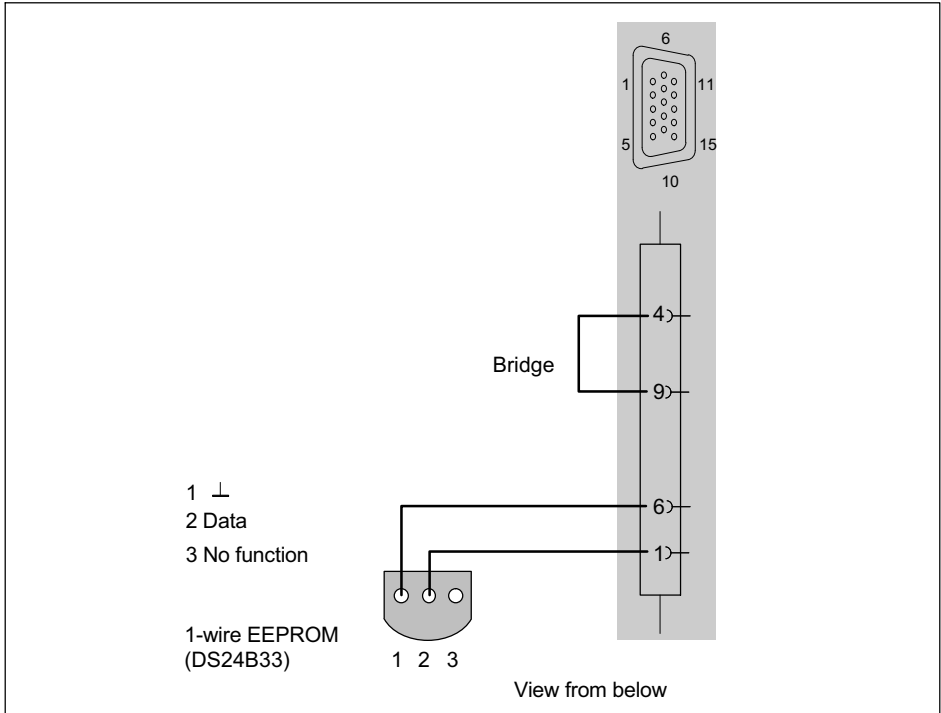

8.1.4 Background calibration / autoadjustment

Measurement channels with full/half bridge mode are cyclically calibrated during the runtime following the start of the module. This mechanism improves long-term stability (aging) and also the short-term stability of an amplifier if there are temperature fluctuations at the site of the measuring device.

Background calibration briefly interrupts measurement and - in place of the measured values from the transducer - sends signals from an internal calibration source to the AD converter (zero and reference signal).

Background calibration is available for the following amplifiers: MX840B, MX440B, MX1615B, MX430B and MX238B.

These amplifiers have a second measurement circuit in the full/half bridge measurement mode, which measures in parallel to the input circuit and implements a calibration cycle in a 30 second rhythm. This ensures long-term and short-term stability in the circuit. The accuracy of the calibration channel is then transferred to the measurement channel with a patented process.

These channels therefore demonstrate high stability with respect to self-heating.

Background calibration can be parameterized with the QuantumX Assistant or using catmanEASY®.

Background calibration is switched on the default settings. The cyclical calibration can be parameterized via the QuantumX Assistants and via catmanEASY®.

8.2 MX840/A/B universal amplifier



Important

There are three MX840 generations:

MX840 : 2008 version

MX840A: 2011 version



MX840B: 2015 version













Extended function:



- IEPE transducers and strain gauge bridge with DC supply
- Decimal rates (switchable)
- Ethernet-based synchronization via IEEE1588:2008 (PTPv2)
- 40 kS/s sample rate per channel, 7.2 kHz bandwidth

The MX840B universal amplifier provides 8 channels. Every channel supports over 15 different transducer technologies. The pin assignment of the 15-pin D-SUB-15HD connector with the respective transducer technology or function is identical for all amplifiers using D-SUB-15HD. All measuring channels are electrically isolated from one another and from the mains. When using the adjustable transducer excitation, electrical isolation from the supply voltage of the amplifier is not required.

MX840B connectable transducers

	Transducer type	Connection sockets	See page
	SG full bridge	1 ... 8	120
	SG quarter bridge via external adapter	1 ... 8	127
	Inductive full bridge	1 ... 8	121

	Transducer type	Connection sockets	See page
	Inductive half bridge	1 ... 8	126
	LVDT	1 ... 8	131
	Electrical voltage	1 ... 8	134, 135
	High-voltage via external adapter (300 V CAT II)	1 ... 8	137
	Electrical current	1 ... 8	138
	Piezoresistive transducer	1 ... 8	122
	Current-fed piezoelectric transducer (IEPE, ICP®) via an external adapter	1 ... 8	132
	Potentiometer	1 ... 8	130
	Resistance thermometer PT100, PT1000	1 ... 8	141
	Thermocouple	1 ... 8	142
	Incremental encoder	5 ... 8	from 145
	SSI protocol	5 ... 8	152

	Transducer type	Connection sockets	See page
	Torque/speed (HBM torque transducer)	5 ... 8	146, 155
	Frequency measurement, pulse counting	5 ... 8	from 145
	CAN bus	1	158

8.2.1 MX840B pin assignment

So that insertion or removal of a transducer connection can be unmistakably identified and, with TEDS, the channel is automatically parameterized, Pin 4 and Pin 9 in the connector plug must be bridged! If this bridge is missing, no measurement values will be recorded at the connection!

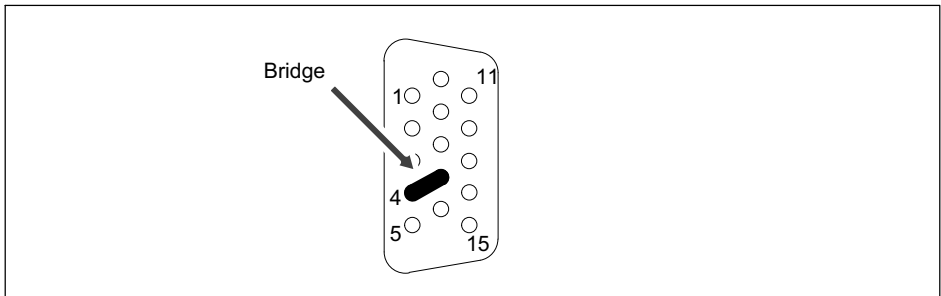

Fig. 8.2 Pin arrangement of connector plug, view from the solder side

Pin	Connector
1	TEDS (+)
2	Bridge excitation voltage (-), 0°-reference pulse (zeroing pulse) (-)
3	Bridge excitation voltage (+), 0°-reference pulse (zeroing pulse) (+)
4	Always connect with Pin 9! (Plug-in detection)
5	Measurement signal (+), potentiometer measurement signal (+), voltage input 100 mV (+), f ₁ (-) signal differential, SSI data (-)

Pin	Connector
6	TEDS (-), ground frequency measurement
7	Sense lead (-), $f_2(-)$ signal differential, CAN-High, SSI clock (-)
8	Sense lead (+), $f_2(+)$ signal differential, CAN-Low, SSI clock (+)
9	Signal ground
10	Measurement signal (-), $f_1(+)$ signal differential, SSI data (+)
11	Active sensor supply 5 ... 24 V (0 V)
12	Active sensor supply 5 ... 24 V (+)
13	Current input ± 30 mA (+)
14	Voltage input 10 V (+), 60 V (+)
15	Digital output

8.2.2 MX840B status display

The front panel of the universal amplifier has a system LED and 8 connection LEDs. The system LED indicates the status of the device, the connection LEDs the states of the individual connections.

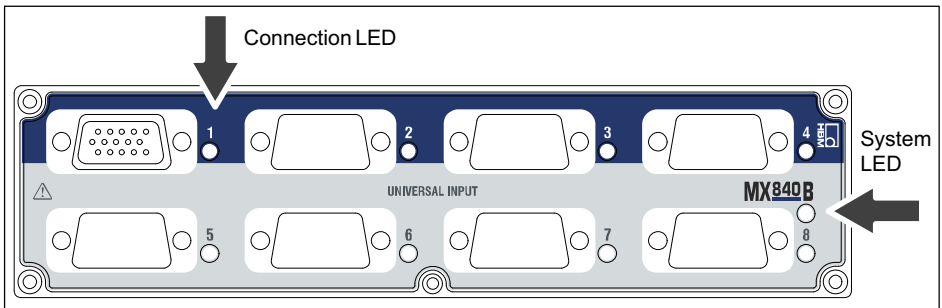

Fig. 8.3 MX840B front view

System LED	
Green	Error-free operation
Orange	System is not ready, boot procedure running
Flashing orange	Download active, system is not ready

Red	Error
Connection LEDs	
All LEDs are orange	Boot procedure running (system is not ready)
All LEDs are flashing orange	Firmware download active (system is not ready)
Orange	Connection newly assigned, transducer identification running (calibration)
Green	Error-free operation
Flashing green (5s), then green	TEDS data being read in
Flashing orange (5 s), then green	Manual configuration ongoing (ignore TEDS)
Red	No sensor connected Channel error (incorrectly parameterized, connection error, invalid TEDS data)
CAN LEDs	
Green	CAN bus activated, CAN data can be received
Orange	CAN bus in "WARNING" state, CAN data received but bus is subject to occasional disruptions; buffer overflow, some data items lost
Red	CAN bus in "ERROR" or "BUS-OFF" state, CAN data cannot be received or processed

General rule: Brief flashing → TEDS identified (green: is used, orange: is not used).

8.3 MX440B universal amplifier

You can connect up to four transducers to the universal amplifier MX440B. The transducers are connected via 15-pin D-SUB-15HD device connectors. All measuring channels are electrically isolated from one another and from the power supply.

Connectable transducer types and the status display are identical with the universal amplifier MX840A (without CAN) (see page 87).

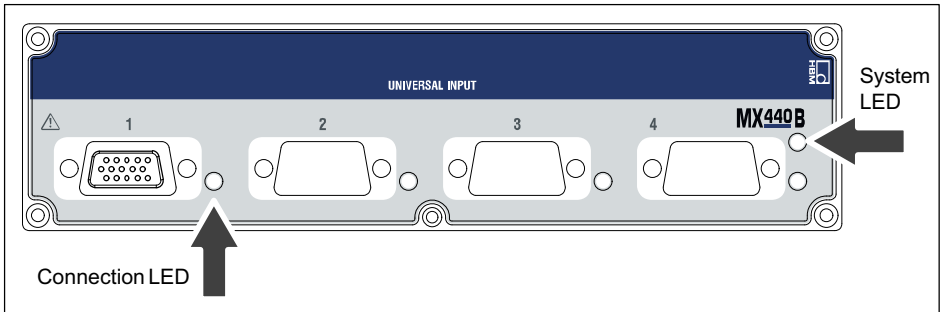

Fig. 8.4 MX440B front view

System LED	
Green	Error-free operation
Orange	System is not ready, boot procedure running
Flashing orange	Download active, system is not ready
Red	Error
Connection LEDs	
All LEDs are orange	Boot procedure running (system is not ready)
All LEDs are flashing orange	Firmware download active (system is not ready)
Orange	Connection newly assigned, transducer identification running (calibration)
Green	Error-free operation
Flashing green (5s), then green	TEDS data being read in
Flashing orange (5 s), then green	Manual configuration ongoing (ignore TEDS)
Red	No sensor connected Channel error (incorrectly parameterized, connection error, invalid TEDS data)









General rule: Brief flashing → TEDS identified (green: is used, orange: is not used).



8.4 MX410B highly dynamic universal amplifier

You can connect up to four transducers to the highly dynamic universal amplifier MX410B. The transducers are connected via 15-pin D-SUB-15HD device connectors. You will need BNC adapters (accessory 1-IEPEMX410) to connect the IEPE transducers.

All measuring channels are electrically isolated from one another and from the power supply. When using the adjustable transducer excitation, electrical isolation from the supply voltage of the amplifier is not required.

MX410B connectable transducers

	Transducer type	Connection sockets	See page
	SG full bridge	1 ... 4	120
	SG half bridge	1 ... 4	124
	SG quarter bridge via adapter	1 ... 4	127
	Inductive full bridge	1 ... 4	121
	Inductive half bridge	1 ... 4	126
	Electrical voltage	1 ... 4	134, 135
	High-voltage via adapter (300 V CAT II)	1 ... 4	137
	Electrical current	1 ... 4	138

	Transducer type	Connection sockets	See page
	Current-fed piezoelectric transducer (IEPE, ICP®)	1 ... 4	132
	Piezoresistive transducer	1 ... 4	122

8.4.1 MX410B pin assignment

So that insertion or removal of a transducer connection can be unmistakably identified, Pin 4 and Pin 9 in the connector plug must be bridged! If this bridge is missing, no measurement values will be recorded at the connection!

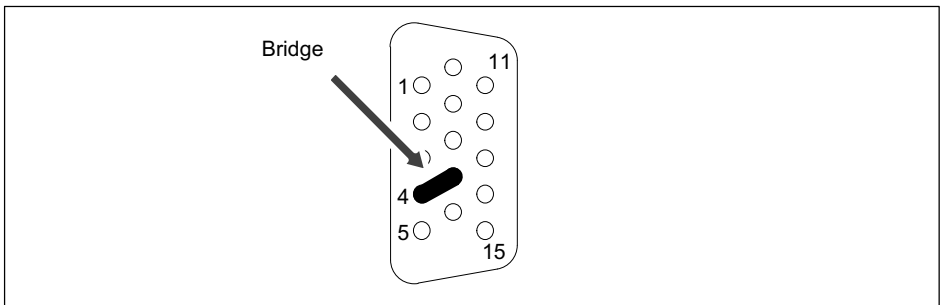

Fig. 8.5 Pin arrangement of connector plug, view from the solder side

Pin	Connector
1	TEDS (+)
2	Bridge excitation voltage (-)
3	Bridge excitation voltage (+)
4	Always connect with Pin 9! (Plug-in detection)
5	Measurement signal (+)
6	TEDS (-)
7	Sense lead (-)
8	Sense lead (+)

Pin	Connector
9	Signal ground
10	Measurement signal (-)
11	Active sensor supply (-)
12	Active sensor supply (+)
13	Current input ± 30 mA (+)
14	Voltage input 10 V, IEPE (+)
15	Digital output, for external charge amplifier, etc., 5 V/max. 10 mA

The analog output can be tapped via BNC. For configuration instructions see section 10 "Functions and outputs".

8.4.2 MX410B status display

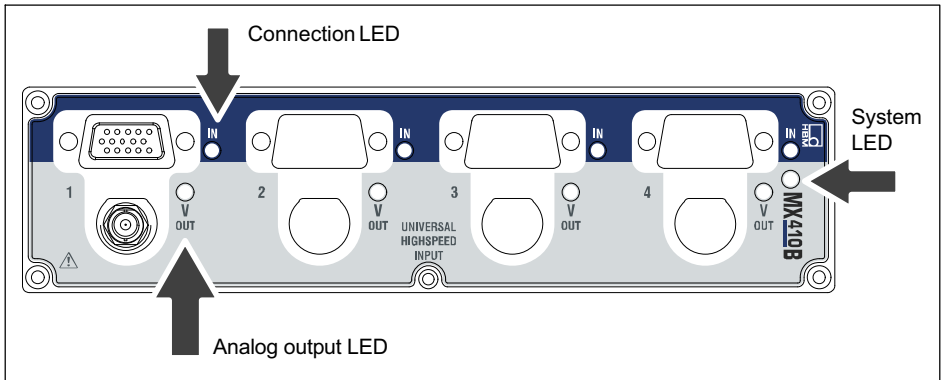

Fig. 8.6 MX410B front view

System LED	
Green	Error-free operation
Orange	System is not ready, boot procedure running
Flashing orange	Download active, system is not ready
Red	Error

Connection LEDs	
All LEDs are orange	Boot procedure running (system is not ready)
All LEDs are flashing orange	Firmware download active (system is not ready)
Orange	Connection newly assigned, transducer identification running (calibration)
Green	Error-free operation
Flashing green (5s), then green	TEDS data being read in
Flashing orange (5 s), then green	Manual configuration ongoing (ignore TEDS)
Red	No sensor connected Channel error (incorrectly parameterized, connection error, invalid TEDS data)
Red	Sensor supply overload
Analog output LEDs	
Green	Error-free operation
Orange	System is not ready, boot procedure running
Red	Overcurrent at the analog output
Orange	Input signal overflow
Red	Overflow due to invalid scaling of the analog outputs

General rule: Brief flashing → TEDS identified (green: is used, orange: is not used).

8.5 MX430B Strain gage fullbridge measuring amplifier

You can connect up to four transducers to the universal amplifier MX430B. The transducers are connected via 15-pin D-SUB-15HD device connectors. All measuring channels are electrically isolated from one another and from the power supply.

MX430B connectable transducers

	Transducer type	Connection sockets	See page
	SG full bridge	1 ... 4	120

8.5.1 MX430B pin assignment

So that insertion or removal of a transducer connection can be unmistakably identified, Pin 4 and Pin 9 in the connector plug must be bridged! If this bridge is missing, no measurement values will be recorded at the connection!

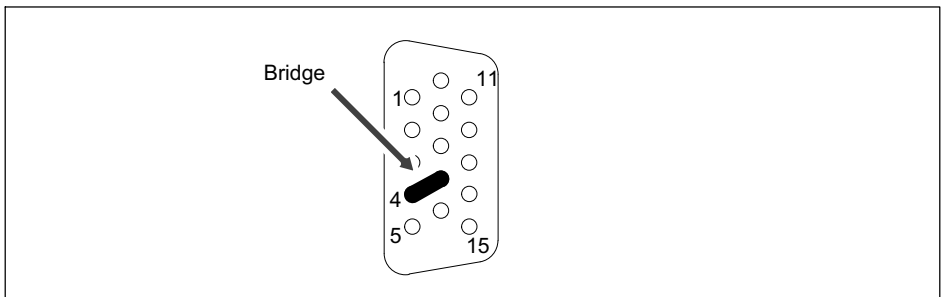

Fig. 8.7 Pin arrangement of connector plug, view from the solder side

Pin	Connector
1	TEDS (+)
2	Bridge excitation voltage (-)
3	Bridge excitation voltage (+)
4	Always connect with Pin 9! (Plug-in detection)

Pin	Connector
5	Measurement signal (+)
6	TEDS (-)
7	Sense lead (-)
8	Sense lead (+)
9	Signal ground
10	Measurement signal (-)
11	Active sensor supply 5 ... 24 V , (-)
12	Active sensor supply 5 ... 24 V (+)
13	Free
14	Free
15	Digital output

8.5.2 MX430B status display

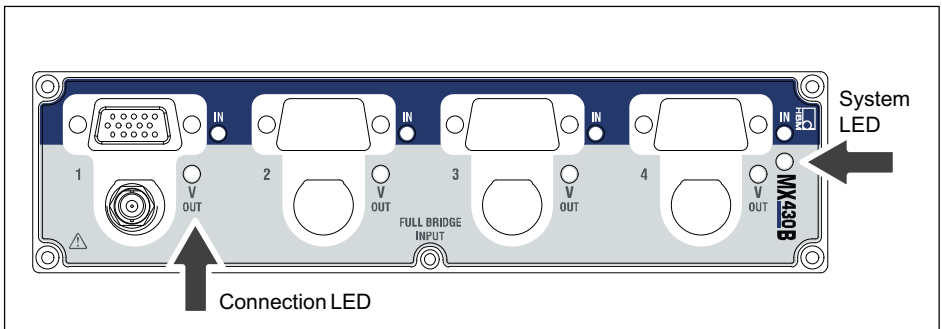

Fig. 8.8 MX430B front view

System LED	
Green	Error-free operation
Orange	System is not ready, boot procedure running
Flashing orange	Download active, system is not ready
Red	Error

Connection LEDs	
All LEDs are orange	Boot procedure running (system is not ready)
All LEDs are flashing orange	Firmware download active (system is not ready)
Orange	Connection newly assigned, transducer identification running (calibration)
Green	Error-free operation
Flashing green (5 s), then green	TEDS data being read in
Flashing orange (5 s), then green	Manual configuration ongoing (ignore TEDS)
Red	No sensor connected Channel error (incorrectly parameterized, connection error, invalid TEDS data)
CAN LEDs	
Green	CAN bus activated, CAN data can be received
Orange	CAN bus in "WARNING" state, CAN data received but bus is subject to occasional disruptions; buffer overflow, some data items lost
Red	CAN bus in "ERROR" or "BUS-OFF" state, CAN data cannot be received or processed

General rule: Brief flashing → TEDS identified (green: is used, orange: is not used).

8.6 MX238B Strain gage fullbridge measuring amplifier

You can connect up to four transducers to the universal amplifier MX238B. The transducers are connected via 15-pin D-SUB-15HD device connectors. All measuring channels are electrically isolated from one another and from the power supply.

MX238B connectable transducers

	Transducer type	Connection sockets	See page
	SG full bridge	1 ... 2	120

8.6.1 MX238B pin assignment

So that insertion or removal of a transducer connection can be unmistakably identified, Pin 4 and Pin 9 in the connector plug must be bridged! If this bridge is missing, no measurement values will be recorded at the connection!

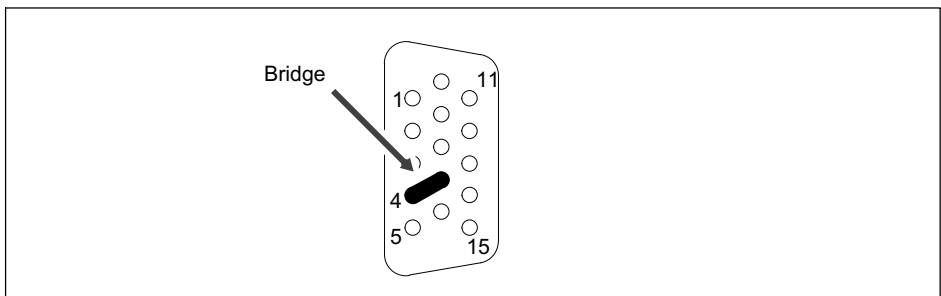

Fig. 8.9 Pin arrangement of connector plug, view from the solder side

Pin	Connector
1	TEDS (+)
2	Bridge excitation voltage (-)
3	Bridge excitation voltage (+)
4	Always connect with Pin 9! (Plug-in detection)

Pin	Connector
5	Measurement signal (+)
6	TEDS (-)
7	Sense lead (-)
8	Sense lead (+)
9	Signal ground
10	Measurement signal (-)
11	Active sensor supply 5 ... 24 V , (-)
12	Active sensor supply 5 ... 24 V (+)
13	Free
14	Free
15	Digital output

8.6.2 MX238B status display

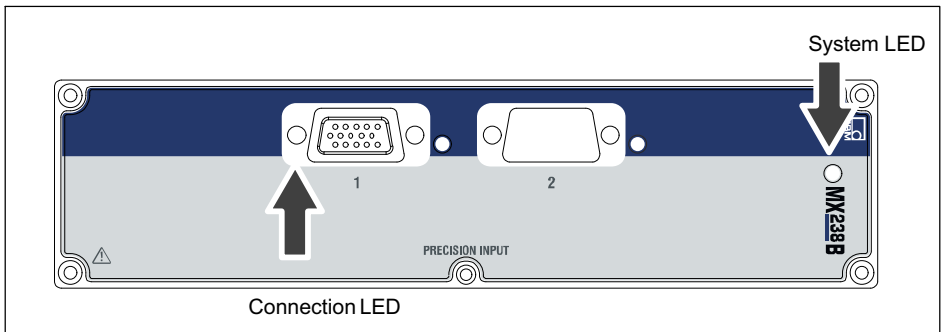

Fig. 8.10 MX238B front view

System LED	
Green	Error-free operation
Orange	System is not ready, boot procedure running
Flashing orange	Download active, system is not ready
Red	Error





Connection LEDs	
All LEDs are orange	Boot procedure running (system is not ready)
All LEDs are flashing orange	Firmware download active (system is not ready)
Orange	Connection newly assigned, transducer identification running (calibration)
Green	Error-free operation
Flashing green (5s), then green	TEDS data being read in
Flashing orange (5 s), then green	Manual configuration ongoing (ignore TEDS)
Red	No sensor connected Channel error (incorrectly parameterized, connection error, invalid TEDS data)
CAN LEDs	
Green	CAN bus activated, CAN data can be received
Orange	CAN bus in "WARNING" state, CAN data received but bus is subject to occasional disruptions; buffer overflow, some data items lost
Red	CAN bus in "ERROR" or "BUS-OFF" state, CAN data cannot be received or processed

General rule: Brief flashing → TEDS identified (green: is used, orange: is not used).

8.7 MX460B frequency amplifier

You can connect up to four transducers to the frequency measuring amplifier MX460B. The transducers are connected via 15-pin D-SUB-15HD device connectors. All measuring channels are electrically isolated from one another and from the power supply. When using the adjustable transducer excitation, electrical isolation from the supply voltage of the amplifier is not required.

MX460B connectable transducers

	Transducer type	Connection sockets	See page
	Torque/speed (HBM torque transducer)	1 ... 4	146, 155
	Frequency measurement, pulse counting	1 ... 4	from 145
	Pulse width, pulse duration, period duration (PWM)	1 ... 4	157
	Passive inductive encoder	1 ... 4	154
	Incremental encoder	1 ... 4	from 145

8.7.1 MX460B pin assignment

So that insertion or removal of a transducer connection can be unmistakably identified, Pin 4 and Pin 9 in the connector plug must be bridged! If this bridge is missing, no measurement values will be recorded at the connection!

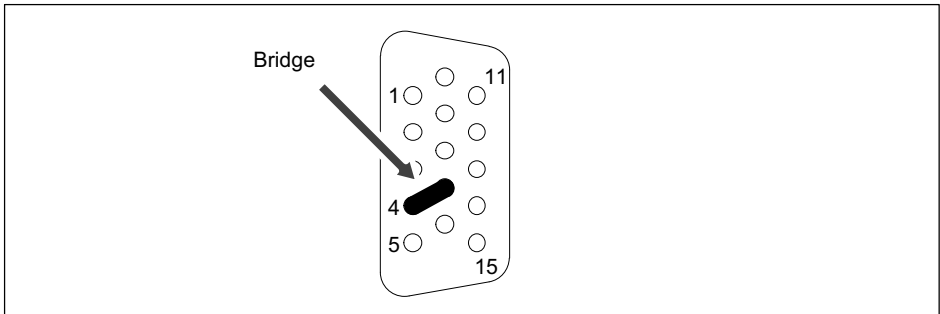

Fig. 8.11 Pin arrangement of connector plug, view from the solder side

Pin	Connector
1	TEDS (+)
2	Reference pulse 0° (zeroing pulse) (-)
3	Reference pulse 0° (zeroing pulse) (+)
4	Always connect with Pin 9! (Plug-in detection)
5	Frequency input f_1 (-)
6	TEDS (-), signal ground
7	Frequency input f_2 (-)
8	Frequency input f_2 (+)
9	Reference voltage V_{ref} (2.5 V)
10	Frequency input f_1 (+)
11	Active sensor supply 5 ... 24 V (-)
12	Active sensor supply 5 ... 24 V (+)
13	Not in use
14	f_1 AC+ (for passive inductive transducers)
15	Digital output, for example to activate a calibration signal for T10F(S) and T40, 5 V/max. 10 mA

8.7.2 MX460B status display

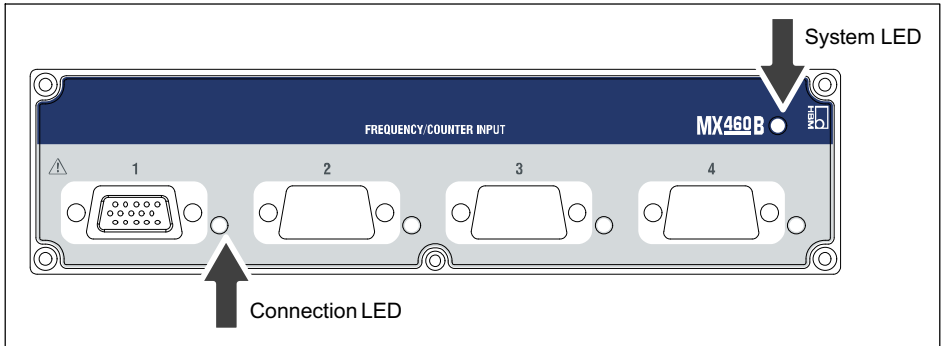

Fig. 8.12 MX460B front view

System LED	
Green	Error-free operation
Orange	System is not ready, boot procedure running
Flashing orange	Download active, system is not ready
Red	Error
Connection LEDs	
All LEDs are orange	Boot procedure running (system is not ready)
All LEDs are flashing orange	Firmware download active (system is not ready)
Orange	Connection newly assigned, transducer identification running (calibration)
Green	Error-free operation
Flashing green (5s), then green	TEDS data being read in
Flashing orange (5 s), then green	Manual configuration ongoing (ignore TEDS)
Red	No sensor connected Channel error (incorrectly parameterized, connection error, invalid TEDS data)

General rule: Brief flashing → TEDS identified (green: is used, orange: is not used).

8.8 MX1609KB and MX1609TB thermocouple amplifier

Up to 16 type K thermocouples (NiCr-NiAl) can be connected to the module MX1609/KB for measuring temperatures.

Up to 16 type T thermocouples (Cu-CuNi) can be connected to the module MX1609T/TB for measuring temperatures.

Connectable to MX1609 transducers

	Transducer type	Connection sockets	See page
	Thermocouple type K, type T	1 ... 16	142

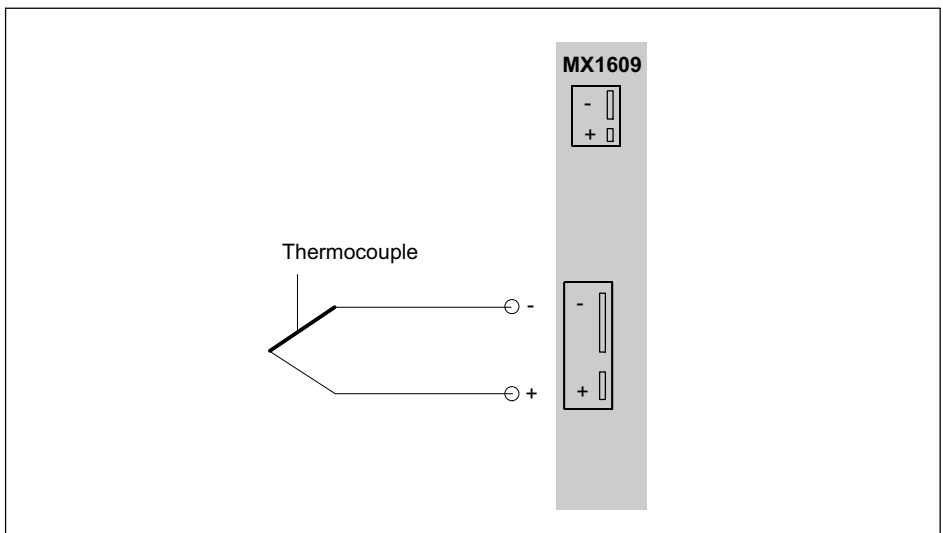

Type	Thermocouple material 1 (+)	Thermocouple material 2 (⊖)
K	Nickel-chrome (color code green)	Nickel-aluminum (color code white)
T	Copper (color code brown)	Copper-nickel (color code white)

Connection of the thermocouple plug in the miniature design.

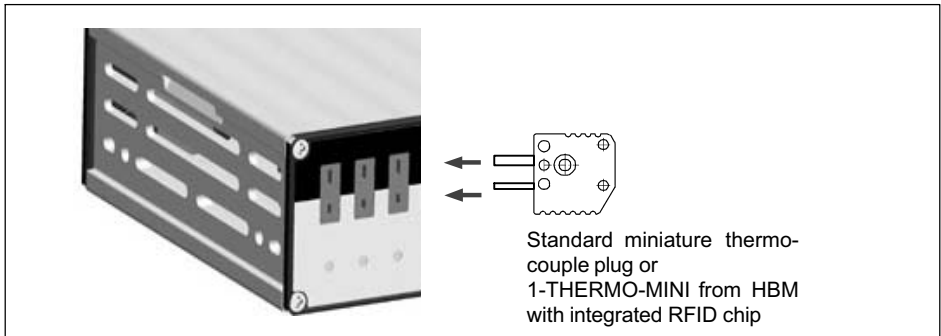

8.8.1 Thermocouple with TEDS functionality (RFID)

Measuring point identification

An RFID³¹⁾ chip in or on the thermocouple plug ensures wireless transducer identification through the amplifier. RFID technology enables contactless reading and writing of data such as the precise measuring point or the required physical unit (5C or °K). Data is entered with the TEDS Editor provided by HBM. It is then written to the RFID chip via a corresponding RFID transponder in the amplifier.

The chip is reusable and works without batteries.

Rescaling

All modules MX1609/KB/TB has a rescaling function. Errors from thermocouples or installation situations can be minimized using a table that converts values from degree °C to degree °C.

The MX1609/KB/TB can process maximum 64 value pairs. 14 value pairs can be stored in the TEDS template "Calibration Table" if no additional optional templates are used.

This function delivers the best results when the ambient temperature of the MX1609/KB/TB, and therefore the temperature of the cold junction, is kept constant.

³⁾ RFID = Radio Frequency Identification: Method for communication between transponder and read/write device with magnetic fields or electromagnetic waves.

Conditions for using RFID chips for measuring point identification:

- All channels can read/write via RFID
- The neighboring channel must not be occupied in the MX1609/KB/TB during writing
- Maximum distance chip to housing: 1 mm
- For self-assembly: Check position of chip on plug

Thermocouple plug with integrated RFID chip from HBM

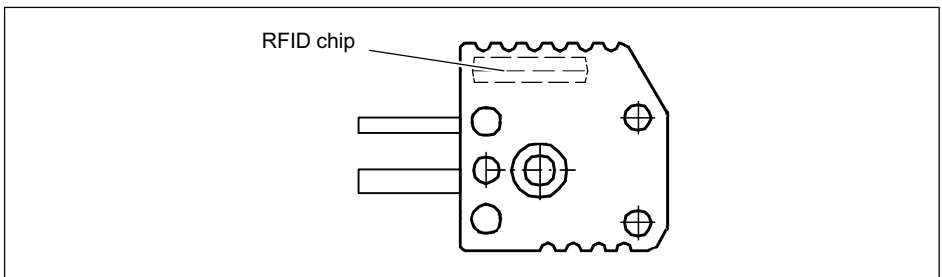

The chip for measuring point identification is already integrated in the HBM THERMO-MINI.

8.8.2 MX1609 status display

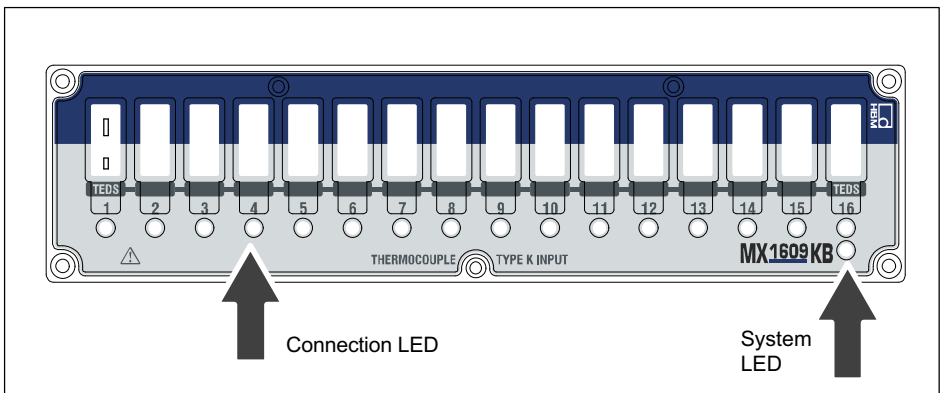

Fig. 8.13 MX1609KB front view

System LED	
Green	Error-free operation
Orange	System is not ready, boot procedure running
Flashing orange	Download active, system is not ready
Red	Error
Connection LEDs	
All LEDs are orange	Boot procedure running (system is not ready)
All LEDs are flashing orange	Firmware download active (system is not ready)
Orange	Connection newly assigned, transducer identification running (calibration)
Green	Error-free operation ("Ignore TEDS" or "if available" set, channel is manually configured)
Flashing green (5s), then green	Error-free operation ("Use TEDS" or "if available" set and TEDS data valid)
Red	No sensor connected Channel error (incorrectly parameterized, connection error, invalid TEDS data)
Red	Sensor supply overload

General rule: Brief flashing → TEDS identified (green: is used, orange: is not used).

8.9 MX471B/C CAN module

8.9.1 General information

The MX471B module provides four independent CAN bus nodes that are all electrically isolated from each other and the power supply. This also applies to the MX471C module, which will replace the MX471B in the medium-term, although it currently only supports the receipt of CAN and CAN FD signals.

Connectable MX471B/C buses

	Type	Connector sockets / nodes	See page
	CAN bus (high-speed CAN)	1 ... 4	158

Connected devices are not directly addressed during data transmission on a CAN bus. A unique identifier denotes the contents of a message (e.g. rotational speed or engine temperature).

The identifier also signifies the priority of the message.

Message = identifier + signal + additional information

Device connected to the bus = node

Each node on the MX471 can be parameterized either as a receiver or as transmitter (gateway). Parameterization as receiver is described in section 8.9.4. Parameterization as transmitter is described in section 9. The online help that comes with the respective software package provides detailed information about parameterization.

Notice

To ensure normal operation, the CAN bus needs to be terminated at both ends, and only there, using appropriate termination resistors. A 120-ohm termination resistor can be individually connected in the module by software. Termination is also required when short cables with low bit rates are used.

Please refer to the data sheet for the relation between bit rate and maximum bus line length.

The configuration of a node is retained after switching the modules off and on.

For decoding signals at a rate greater than 2000/s, please set up signal inputs 1 to 8 on the MX471. The signal buffers of these signal inputs have been expanded accordingly.

8.9.2 MX471B/C pin assignment

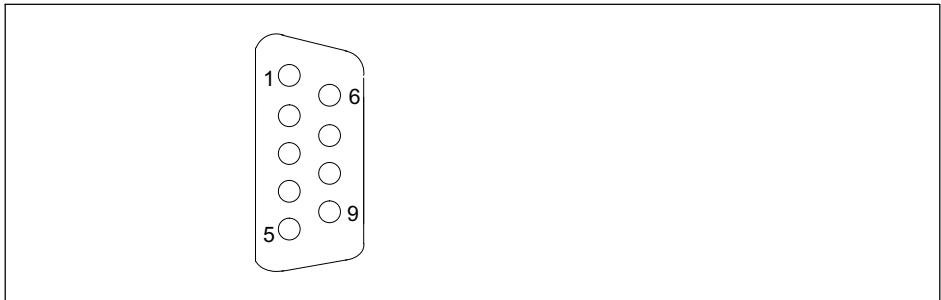

Fig. 8.14 Pin arrangement of connector plug, view from the solder side

Pin	Connector
1	No function
2	CAN Low
3	GND
4	No function

Pin	Connector
5	CAN Shield
6	GND
7	CAN High
8	No function
9	No function

8.9.3 MX471B status LEDs

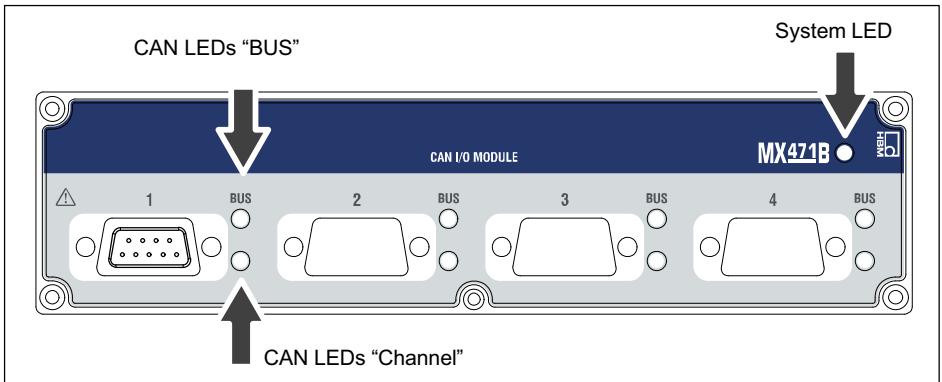

Fig. 8.15 MX471B front view

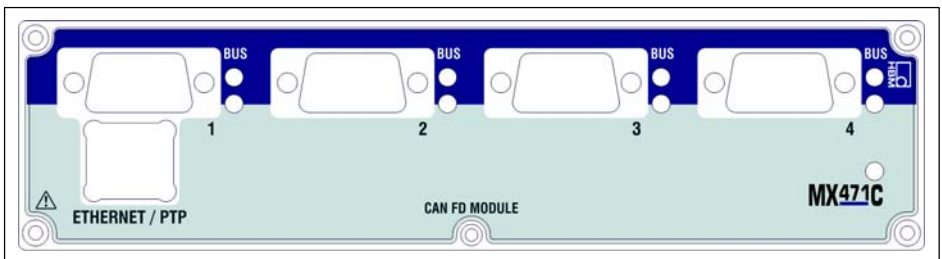

Fig. 8.16 MX471C front view

System LED

Green	Error-free operation
Yellow	System is not ready, boot procedure running
Flashing yellow	Download active, system is not ready
Red	Error, faulty synchronization

CAN-LEDs (BUS)

Green flickering	Bus is error-free and activity on CAN
Constant green	Bus is error-free and no activity on CAN
Yellow flickering	Intermittent bus errors (warning) and activity on CAN
Constant yellow	Intermittent bus errors (warning) and no activity on CAN
Red on	Bus error, CAN interface in "Bus-OFF" status

CAN LEDs (channel)

Constant green	Channel is ready for operation
Flashing yellow	Firmware1 download active
Yellow on	Boot process running
Red on	Channel has errors

Ethernet LED

Green on	Ethernet link status is OK
Flashing yellow	Ethernet data transmission ongoing

8.9.4 Receiving CAN messages

To be able to receive CAN messages, the node must be able to identify the relevant messages. This can be done directly on the node or, in a reproducible way, by previously generated messages in the sensor database. Individual

messages can be linked to the node by dragging from the sensor database and dropping them where required.

CAN databases type *.dbc can also be read into the sensor database. If no CAN database is available, it can also be created. Editors for this purpose are provided by different companies.

Received CAN messages are instantly "time-stamped" in measurement mode. This enables directly acquired measured quantities and CAN messages to be acquired and analyzed in parallel and synchronously in the entire system.



8.10 MX1601B amplifier

You connect up to 16 freely configurable inputs for voltage (10 V, 100mV) or current (20mA) or current-fed piezoelectric sensors (IEPE) to the MX1601B.

The transducers are connected via 8-pin plug terminal connectors (Phoenix Contact FMC 1.5/8-ST-3.5-RF (order no. 1952089)).

All measuring channels are electrically isolated from one another and from the power supply. When using the adjustable transducer excitation, electrical isolation from the supply voltage of the amplifier is not required.

MX1601B connectable transducers

	Transducer type	Connection sockets	See page
	Electrical voltage	1 ... 16	134, 135
	Electrical current	1 ... 16	138
	Current-fed piezoelectric transducer (IEPE, ICP®) via an external adapter	1 ... 16	132

8.10.1 MX1601B pin assignment

So that insertion or removal of a transducer connection can be unmistakably identified, Pin 2 and Pin 5 in the connector plug must be bridged! If this bridge is missing, no measurement values will be recorded at the connection!

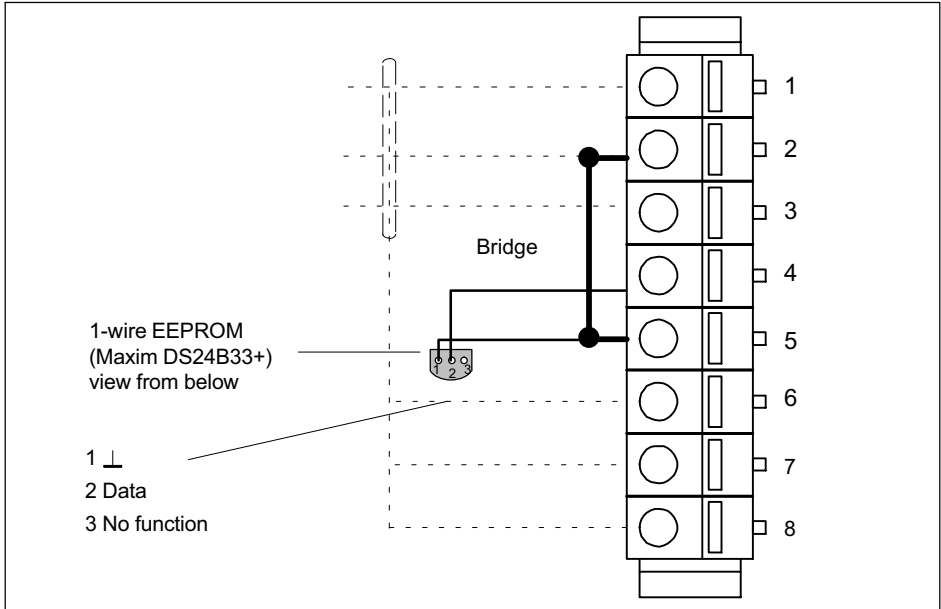

Fig. 8.17 Pin arrangement of connection plug, view from the connection side

Pin	Connector
1	Voltage output 10 V (+), 100 mV (+), IEPE (+)
2	Signal ground, TEDS (-)
3	Current input 20 mA (+)
4	TEDS (+)
5	Always connect with Pin 2! (Plug-in detection)
6	Active sensor supply (+)
7	Active sensor supply (-)
8	Housing (shield connection)

Notice

The transducer excitation voltage can be set in the range of 5 ... 24 V (as described in 6.1.2) is only available on channels 1 ... 8.

On channels 9 ... 16 the supply voltage (10 ... 30 V) from the module (e.g. 24 V) is output less approx. 1 V.

A current of max. 30 mA can be consumed for these channels. The current limitation switches the transducer excitation off if current consumption is higher.

8.10.2 MX1601B status display

The front panel of the universal amplifier has a system LED and 16 connection LEDs. The system LED indicates the status of the device, the connection LEDs the states of the individual connections.

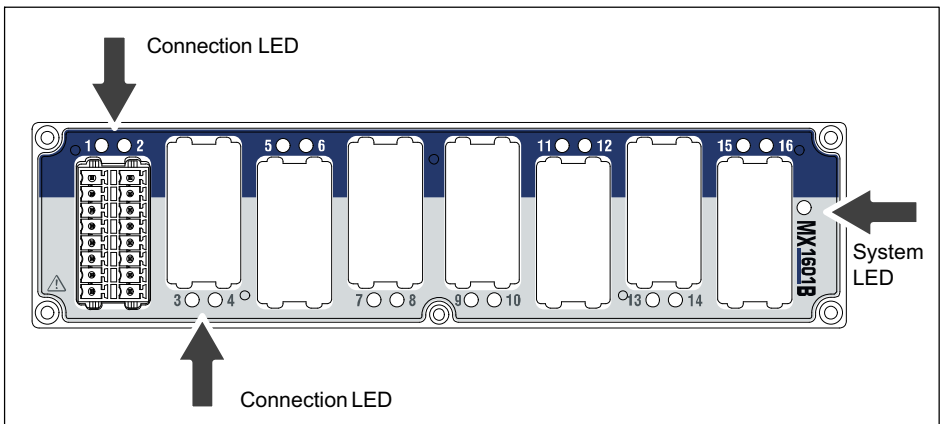

Fig. 8.18 MX1601B front view

System LED	
Green	Error-free operation
Orange	System is not ready, boot procedure running
Flashing orange	Download active, system is not ready

Red	Error
Connection LEDs	
All LEDs are orange	Boot procedure running (system is not ready)
All LEDs are flashing orange	Firmware download active (system is not ready)
Orange	Connection newly assigned, transducer identification running (calibration)
Green	Error-free operation
Flashing green (5s), then green	TEDS data being read in
Flashing orange (5 s), then green	Manual configuration ongoing (ignore TEDS)
Red	Amplifier overload, no sensor connected Channel error (incorrectly parameterized, connection error, invalid TEDS data)
Flashing red	Sensor supply overload

General rule: Brief flashing → TEDS identified (green: is used, orange: is not used).

8.11 MX1615B amplifier

Up to 16 freely configurable inputs can be connected to the MX1615B amplifier.

It supports:

Strain gauges (SG) or SG-based transducers in

- Full bridge circuit (six-wire configuration)
- Half bridge circuit (five-wire configuration)
- Quarter bridge circuit (two, three or four wires for 120 ohms or 350 ohms)

Standardized voltage (± 10 V differential or 0 . . . 30 V DC unipolar)

Resistor-based measurement (PT100 or resistor, implemented in a quarter bridge arm)

Bridge excitation voltage:

Constant DC voltage or 1200 Hz (AC) square wave carrier frequency with an amplitude of 0.5 V; 1 V, 2.5 V or 5 V



When TEDS or T-ID is used, the measurement channel is automatically parameterized after connection.





Extended functionality for MX1615B :

- Potentiometer

When TEDS or T-ID is used, the measurement channel is automatically parameterized after connection.

MX1615B connectable transducers

	Transducer type	Connection sockets	See page
	SG full bridge	1 ... 16	120
	SG half bridge	1 ... 16	124

	Transducer type	Connection sockets	See page
	SG quarter bridge	1 ... 16	124
	Electrical voltage	1 ... 16	134, 135
	Resistance thermometer Pt100	1 ... 16	141
	Ohmic resistor	1 ... 16	140
	Potentiometer (only MX1615B)	1 ... 16	130

The transducers are connected via 8-pin plug terminal connectors (Phoenix Contact FMC 1.5/8-ST-3.5-RFBKBD1-8Q).

The measurement channels are only electrically isolated from the power supply of the MX1615, not from each other.



Important

MX1615B uses the "Mini Combicon AU" socket/plug type from Phoenix with gold pins for sensor connection,

instead of "Mini Combicon" as used with MX1615.

It is essential to make sure that the right connector is used:

MX1615B -> 1-CON-S1015; MX1615 -> 1-CON-S1005.

8.11.1 MX1615B pin assignment

So that insertion or removal of a transducer connection can be unmistakably identified, Pin 4 and Pin 5 in the connector plug must be bridged! This is automatically so for all bridge transducers. The bridge only needs to be completed for voltage measurements. If this bridge is missing, no measurement values will be recorded at the connection!

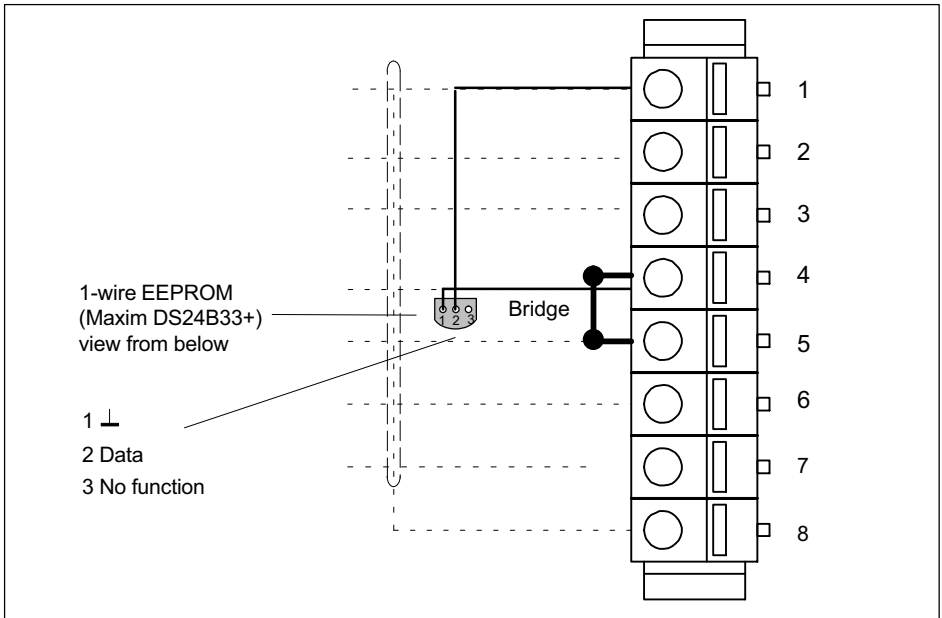

Fig. 8.19 Pin arrangement of connection plug, view from the connection side

Pin	Connector
1	TEDS (+)
2	Bridge excitation voltage (+)
3	Sense lead (+)
4	Bridge excitation voltage (-), (TEDS) (-)
5	Sense lead (-)
6	Measurement signal (+), voltage input 10 V / 30 V (+)
7	Measurement signal (-), voltage input 0 V / 10 V (-), bridge excitation voltage (+) for quarter bridges
8	Housing (shield connection)

8.11.2 MX1615B status display

The front panel of the universal amplifier has a system LED and 16 connection LEDs. The system LED indicates the status of the device, the connection LEDs the states of the individual connections.

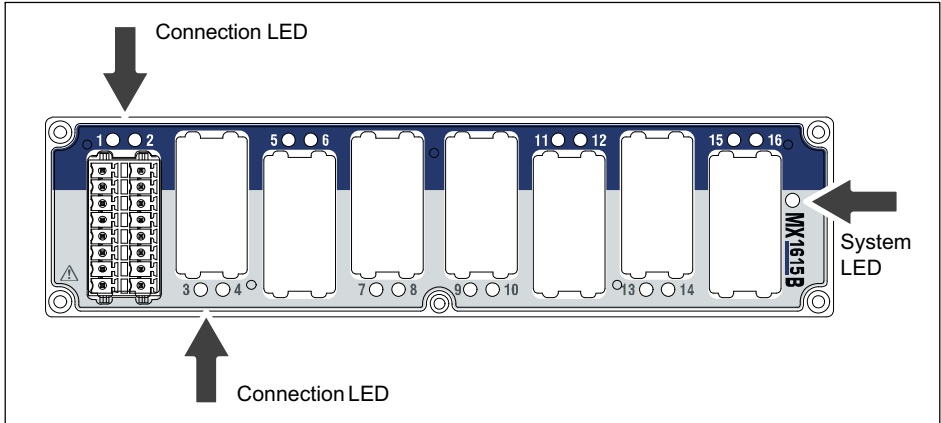

Fig. 8.20 MX1615B front view

System LED	
Green	Error-free operation
Orange	System is not ready, boot procedure running
Flashing orange	Download active, system is not ready
Red	Error
Connection LEDs	
All LEDs are orange	Boot procedure running (system is not ready)
All LEDs are flashing orange	Firmware download active (system is not ready)
Orange	Connection newly assigned, transducer identification running (calibration)
Green	Error-free operation
Flashing green (5s), then green	TEDS data being read in

Flashing orange (5 s), then green	Manual configuration ongoing (ignore TEDS)
Red	Amplifier overload, no sensor connected Channel error (incorrectly parameterized, connection error, invalid TEDS data)
Flashing red	Sensor supply overload

General rule: Brief flashing → TEDS identified (green: is used, orange: is not used).

9 Transducer connection

9.1 Full bridge, SG

Supported by the following modules: MX840B, MX440A, MX410B, MX430B, MX238B, MX1615B/MX1616B

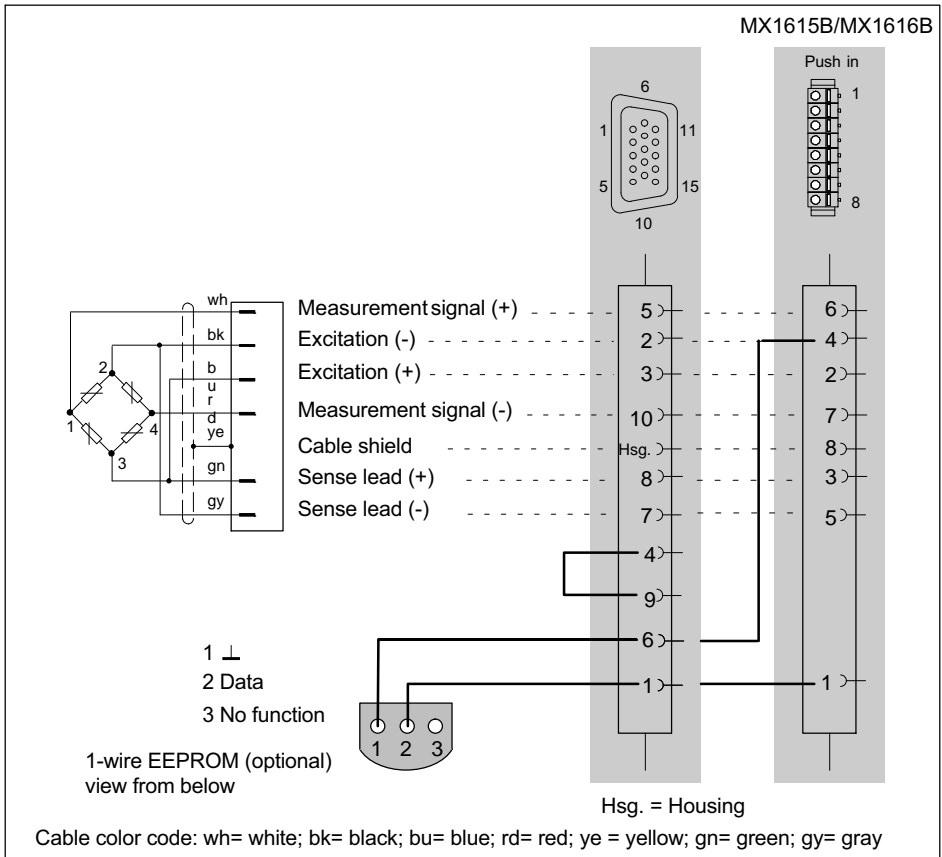

9.2 Full bridge, inductive

Supported by the following modules: MX840B, MX440B, MX410B

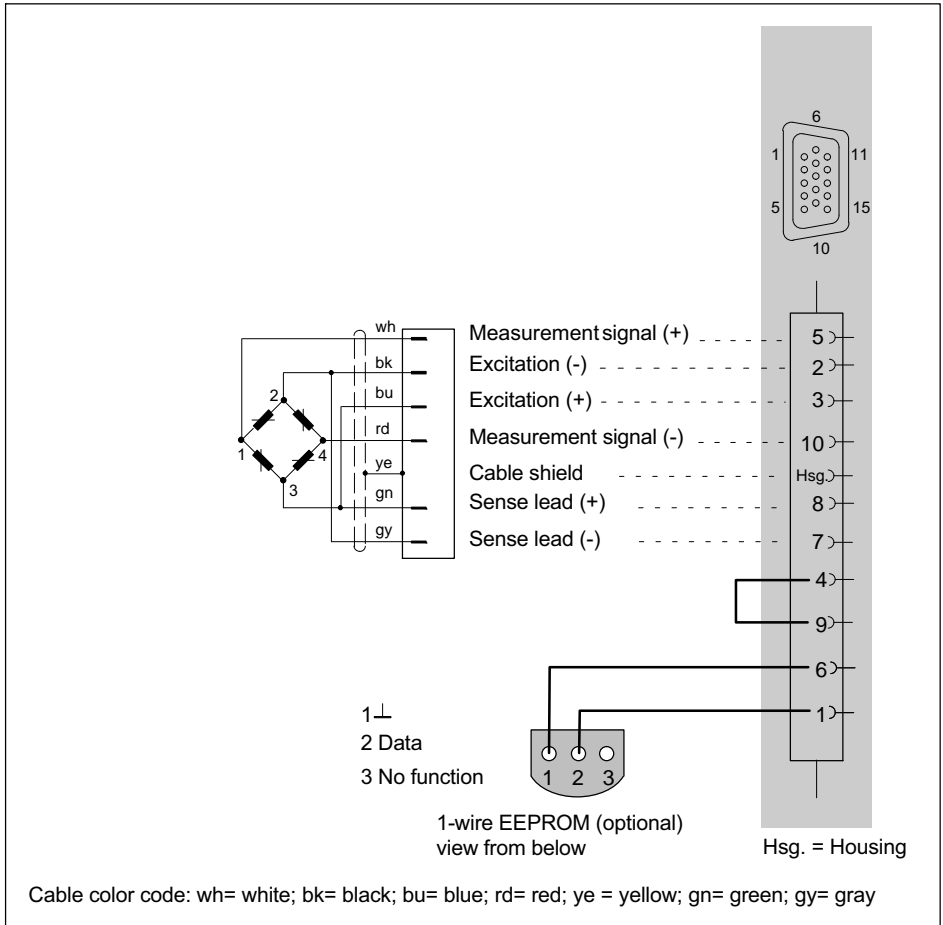

9.3 Full bridge, piezoresistive

Supported by the following modules: MX840B, MX440B, MX410B, MX1615B

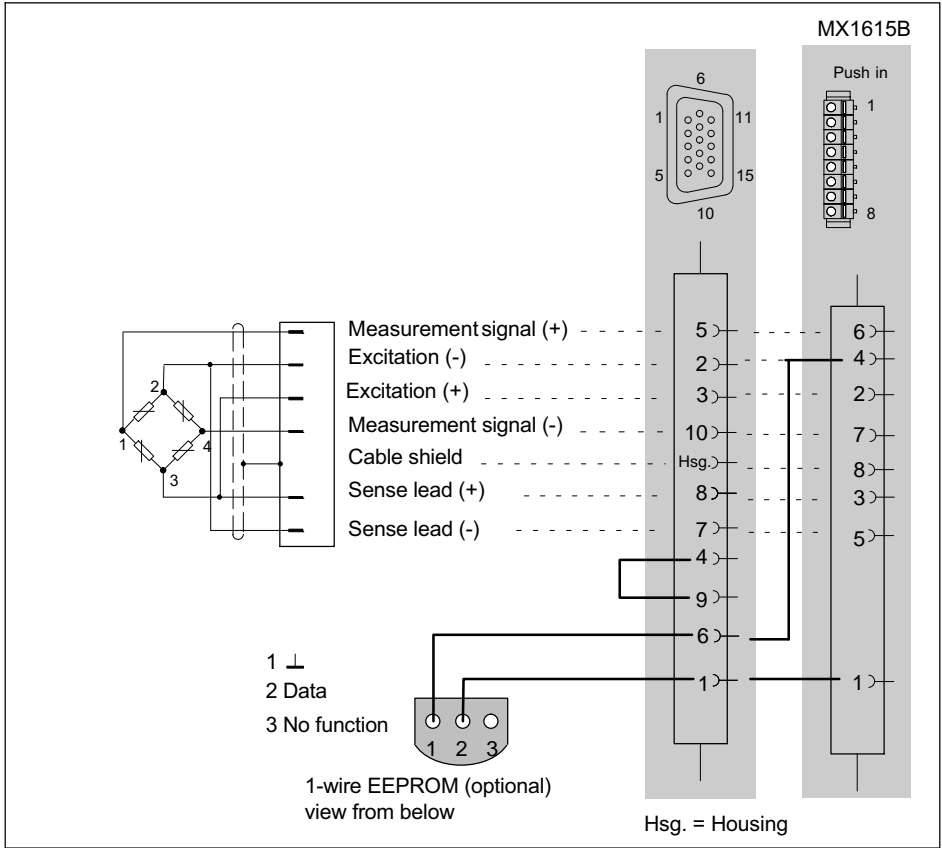

Fullbridge with shunt (with cable regulation)

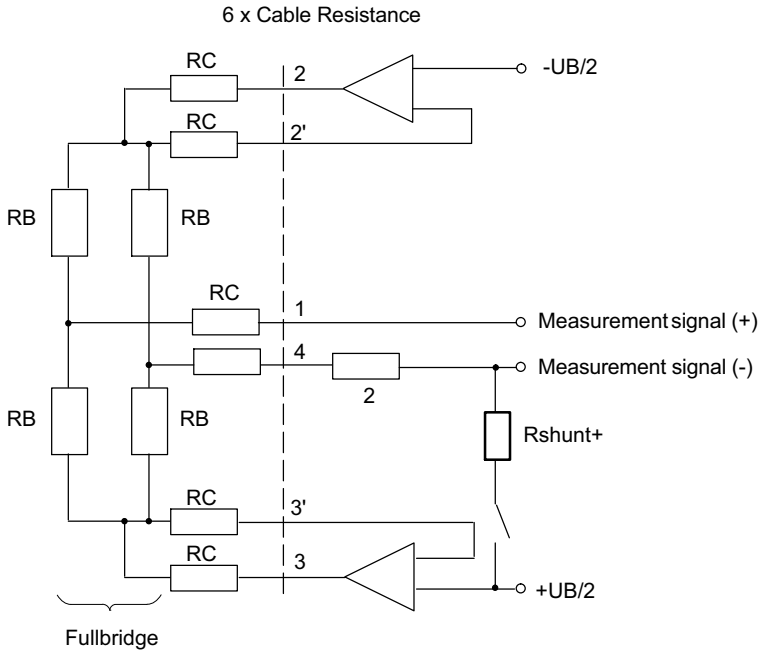

1) Shunt signal only available if 1 and 4 externally connected

9.4 Half bridge, SG

Supported by the following modules: MX840B, MX440B, MX410B, MX1615B

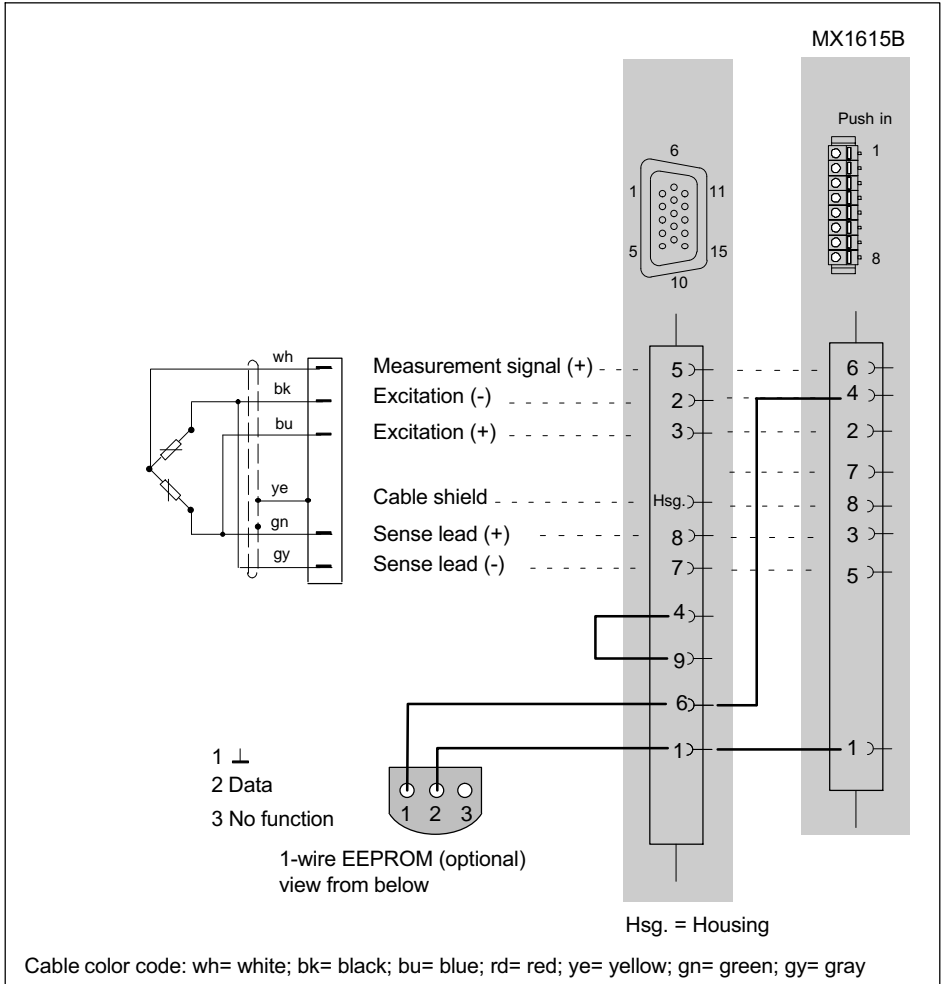

Halfbridge with shunt (with cable regulation)

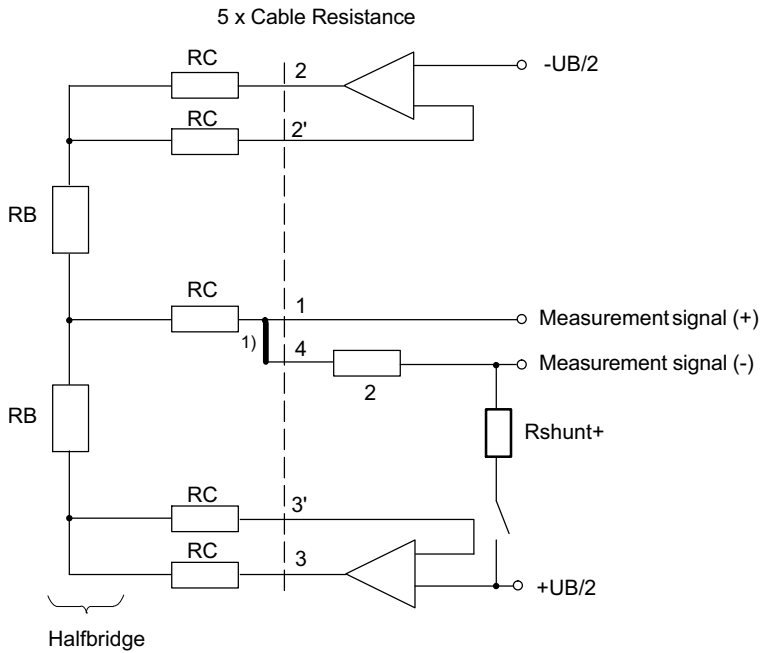

1) Shunt signal only available if 1 and 4 externally connected

9.5 Half bridge, inductive

Supported by the following modules: MX840B, MX440B, MX410B

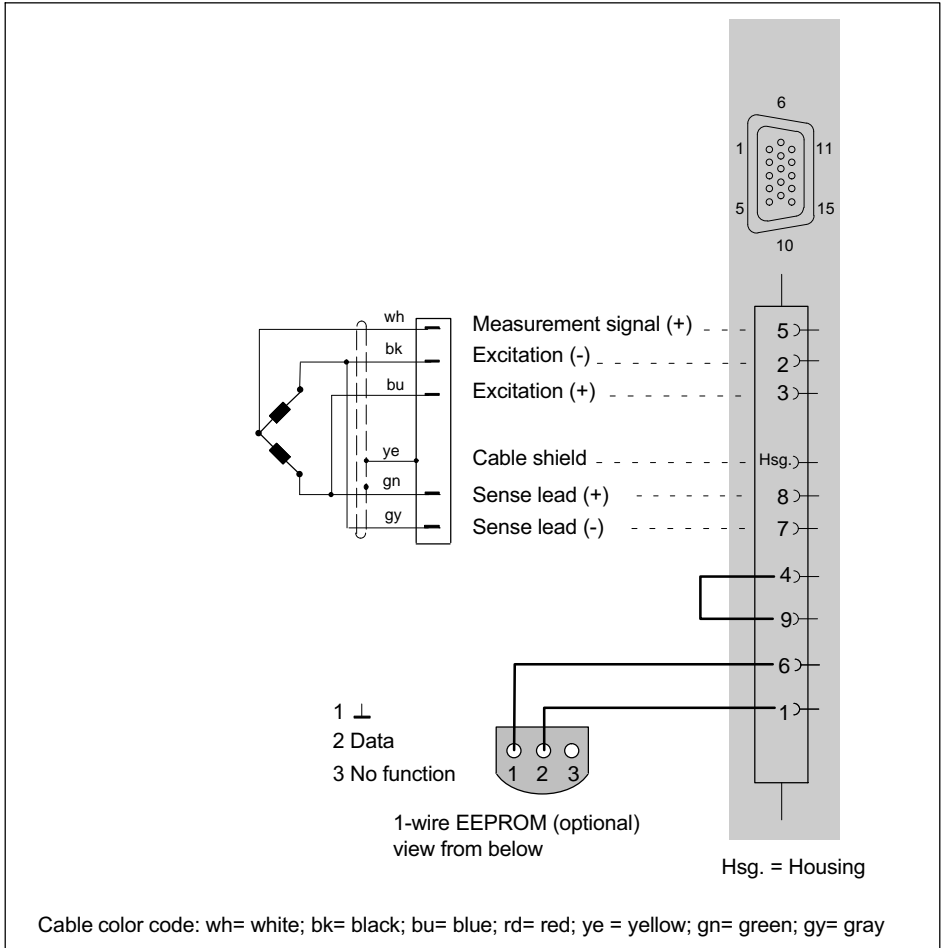

9.6 Quarter bridge, SG

Amplifier with direct support of SG quarter bridges: MX1615B/MX1616B.

Quarter bridges can be connected via an adapter to: MX840B, MX440B, MX430B and MX410B. For connecting individual SGs to this adapter see the following page.

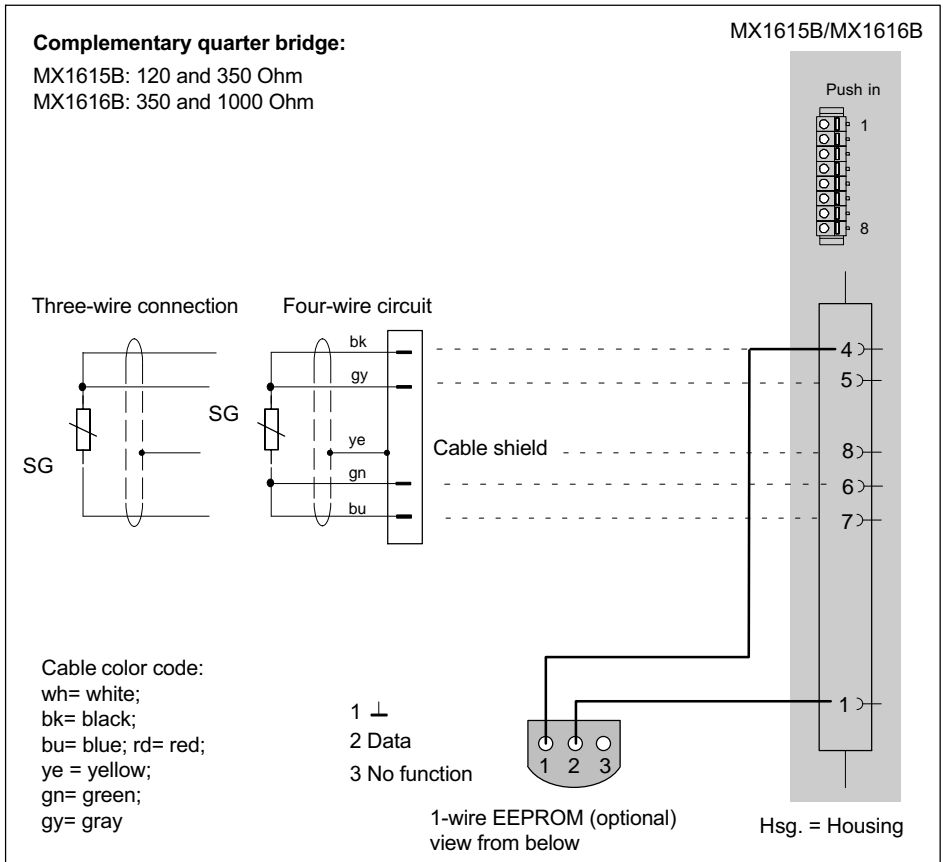

9.7 Adapter quarter bridge, SG

For connecting single quarter-bridge strain gauges in three-wire configuration, an adapter can be plugged onto the following modules:

MX840B, MX440B, MX430B, MX238B, MX410B

Available adapters

SG with 120 ohms: order number: SCM-SG120

Variations: SCM-SG350, SG700, SG1000

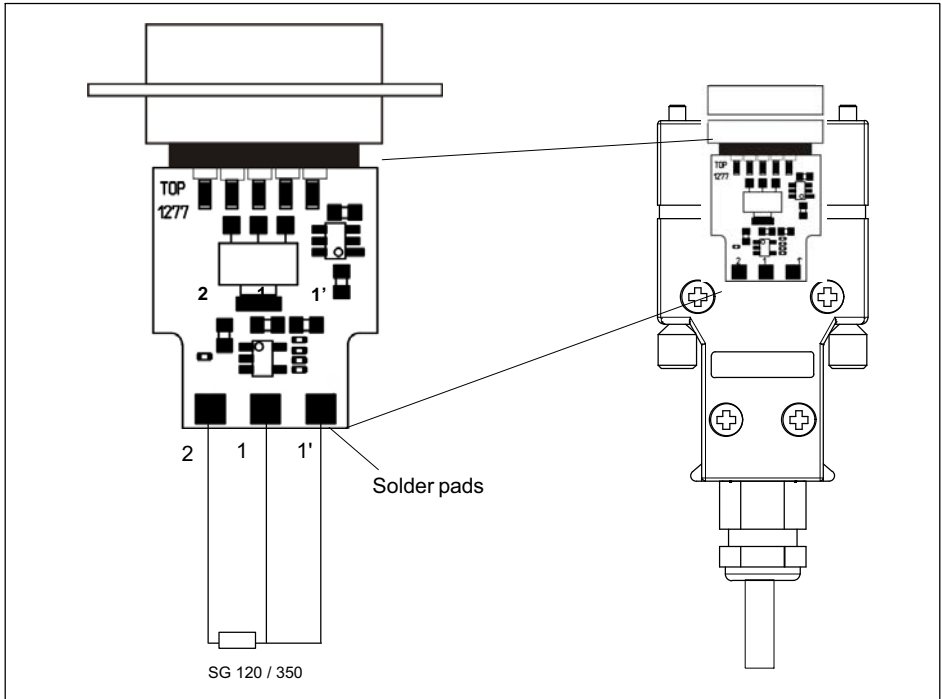

For technical details see the leaflet entitled QuantumX / SCM-SG120/350/700/1000.

9.8 Connecting transducers with double shield technique

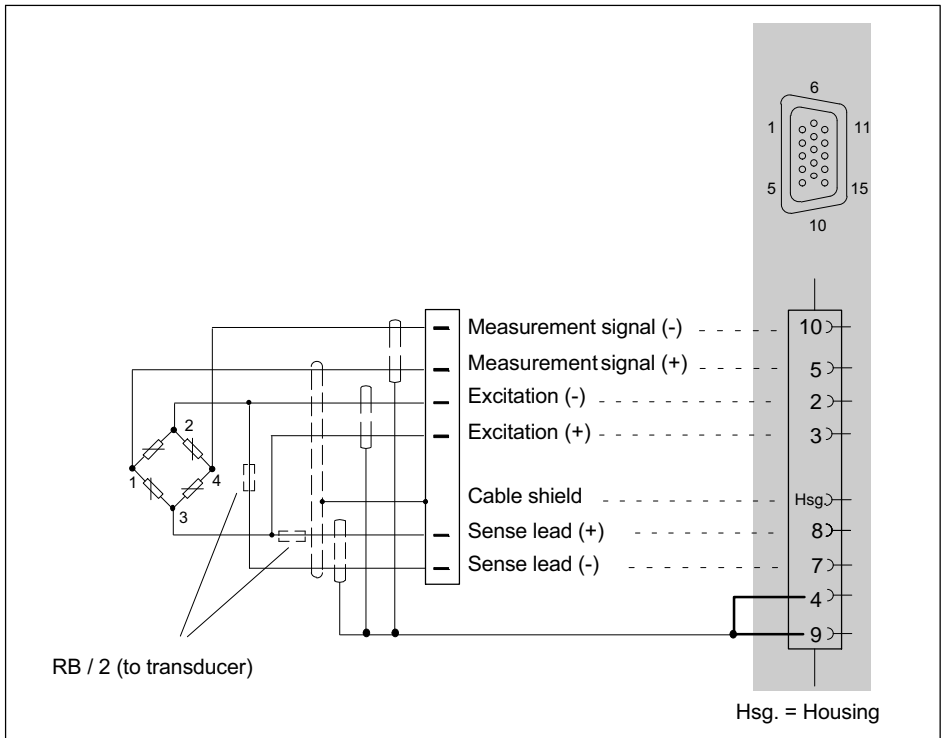

For amplifiers MX840B, MX440A and MX410B, we recommend this connection technique for very small measurement ranges, particularly in environments subject to interference and when using long cables.

This applies for all bridge connections.

With cable lengths >50 m, a resistor with half the value of the bridge resistance (RB/2) must be connected in each sense lead of the transducer.

9.9 Potentiometric transducers

Supported by the following modules: MX840B, MX440A, MX1615B

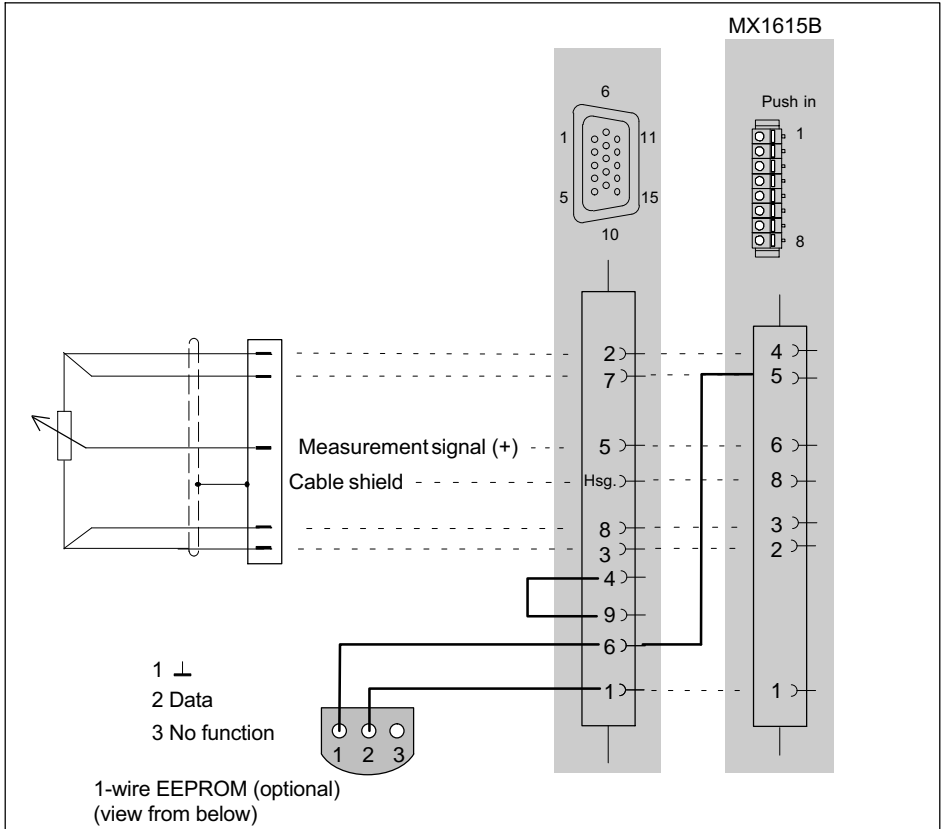

9.10 LVDT transducers

Supported by the following modules: MX840B, MX440A

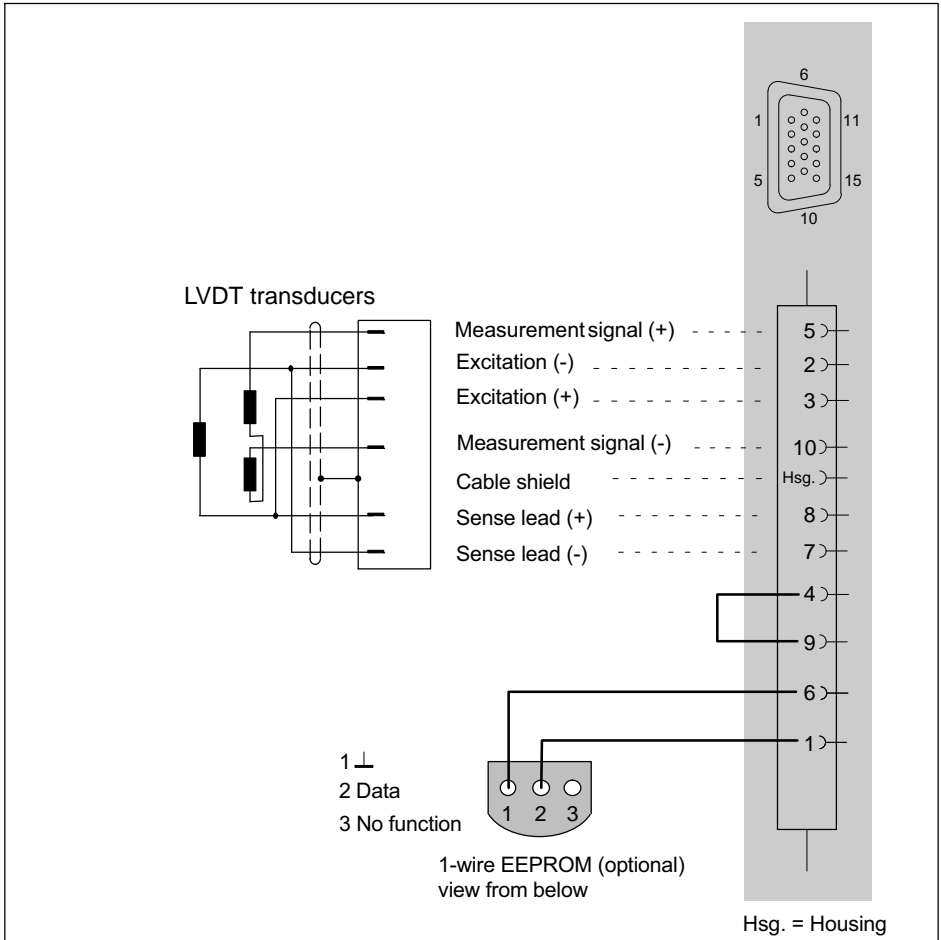

9.11 Current-fed piezoelectric transducer (ICP/IEPE)

Current-fed piezoelectric transducers are supplied with a constant current of e.g. 4 mA. They return a voltage signal to the amplifier. This type of transducer is also called an IEPE or ICP[®] transducer.

IEPE is short for "Integrated Electronics Piezo Electric"

「 α^+ 」 is a registered trademark of "PCB Piezotronics".

Supported by the following modules:

MX410B, MX1601B
MX840B, MX440B

An adapter on SubHD15 (1-SUBHD15-BNC) is available for connecting IEPE transducers with a BNC connector.

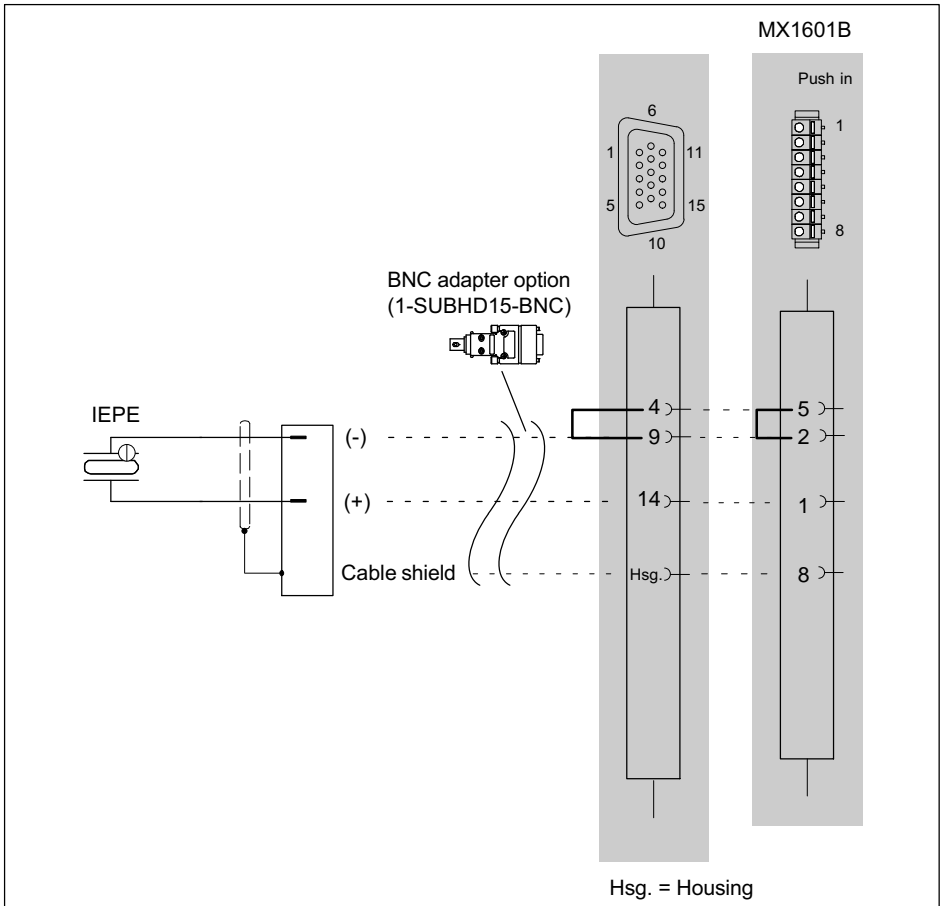

Notice

IEPE transducers with TEDS version 1.0 are supported.

9.12 Electrical voltage 100 mV

Supported by the following modules: MX840B, MX440B, MX1601B

Pin assignment for module MX1601 see section 8.10.1

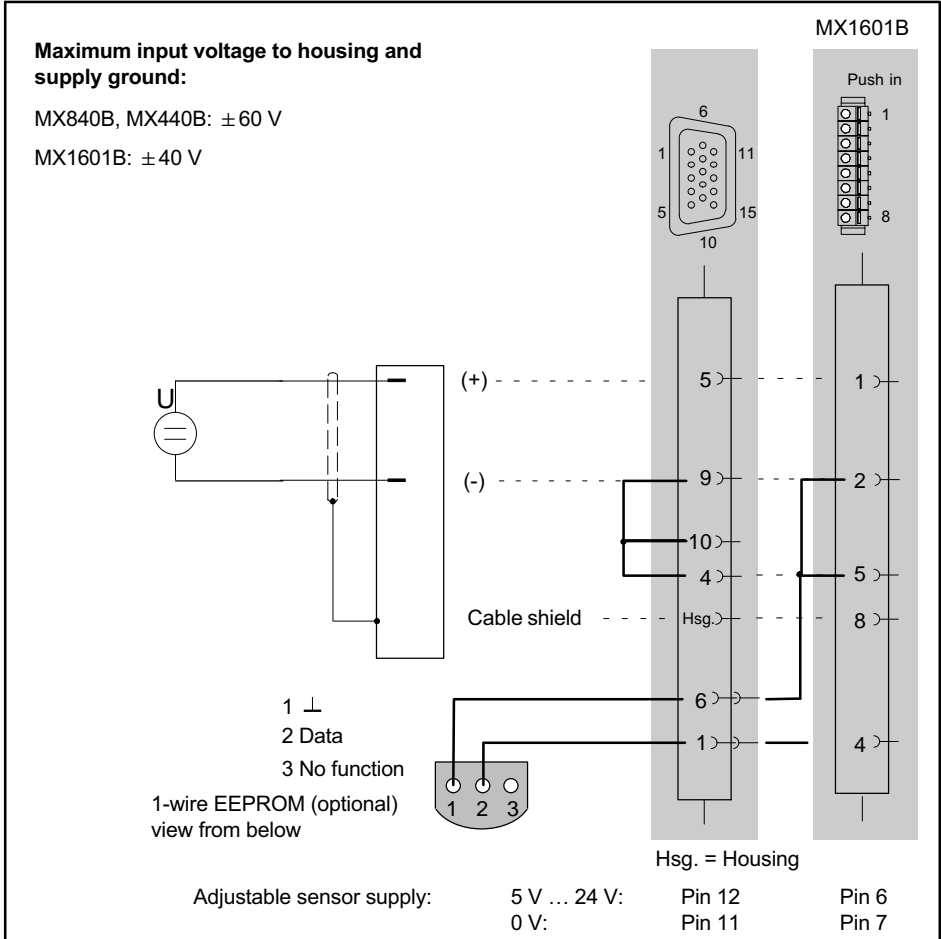

9.13 DC voltage sources 10 V

The following amplifiers support a measuring range of

± 10 V: MX410B, MX840B, MX440B, MX1601B

Pin assignments for MX1601B see *section 8.10.1*

Pin assignment for module MX1615B see *section 8.11.1*

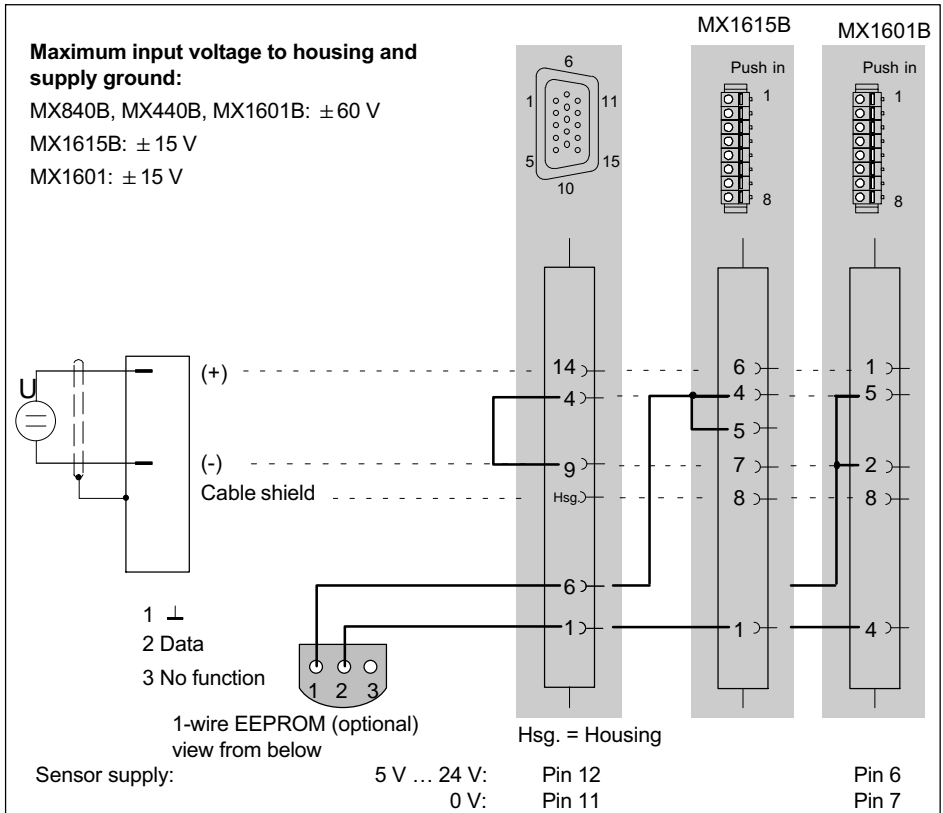

MX1601B: Only channels 1-8 offer an individual sensor supply of 5-24 V
 Channels 9-16 can be activated with a fixed sensor supply (-1 V module supply voltage).

An amplifier that supports the measuring range of ± 10 V can also be parameterized via the software.

9.15 Voltage sources up to 300 V (CAT II)

The signal conditioning module (SCM-V) allows safe acquisition of voltages up to 300 V CAT II, or 10 V at a correspondingly high voltage level in measurement category CAT II, and can be very easily connected to the SubHD connectors of MX840B, MX440B or MX410B amplifiers. SCM-HV was developed in accordance with the most stringent safety requirements, with the focus on safe working. Numerous publications are available with more detailed references to the subject of the (CAT II) measurement category and the underlying international standard.

The SCM-HV is a voltage divider consisting of a protective circuit or isolating circuit. The voltage is measured by two permanently connected lab cables with completely isolated lab connectors.

Due to an integrated 1-wire-EEPROM (TEDS), the SCM-HV is equipped with a detection function for the connected components. After the connection is made the channel is configured automatically. The PC software is capable of linearizing the input and saving it to the adapter.

Separate operating instructions are included in the scope of delivery for the SCM-HV.



9.16 DC current sources 20 mA

Supported by the following modules: MX840B, MX440B, MX410B, MX1601B

Pin assignment for MX1601B see *section 8.10.1*

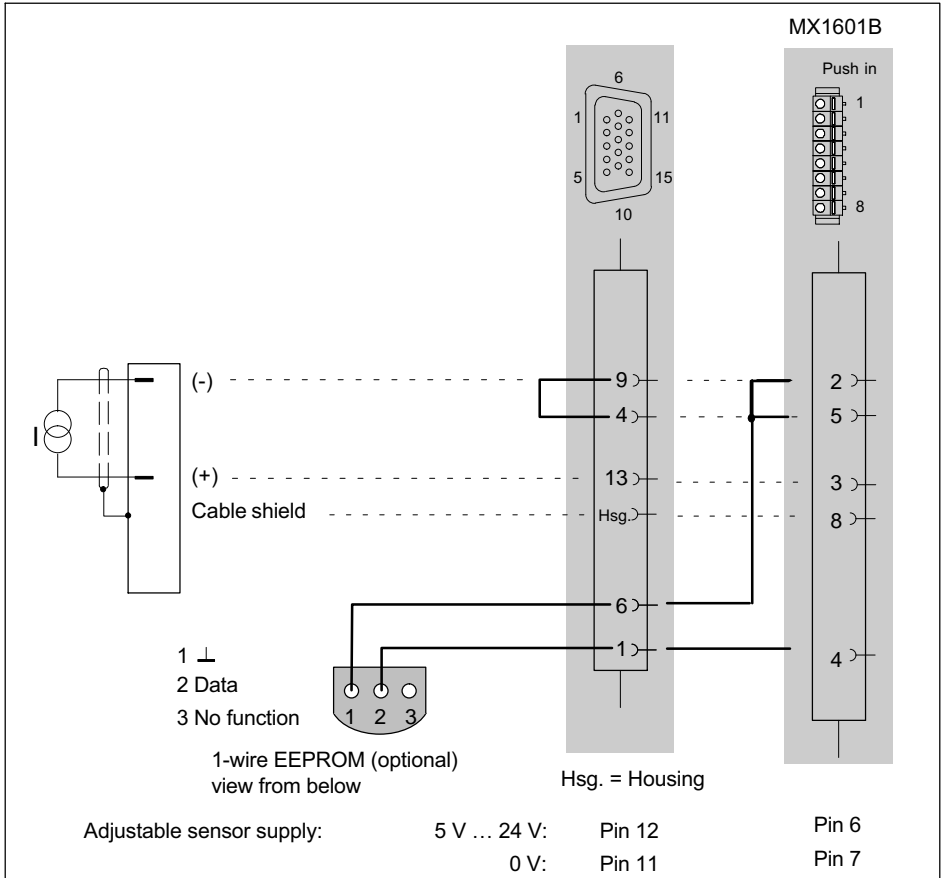

Maximum current ± 30 mA

9.17 DC current sources 20 mA - voltage-fed

Supported by the following modules: MX840B, MX440B, MX410B, MX1601B

Pin assignment for MX1601B see section 8.10.1

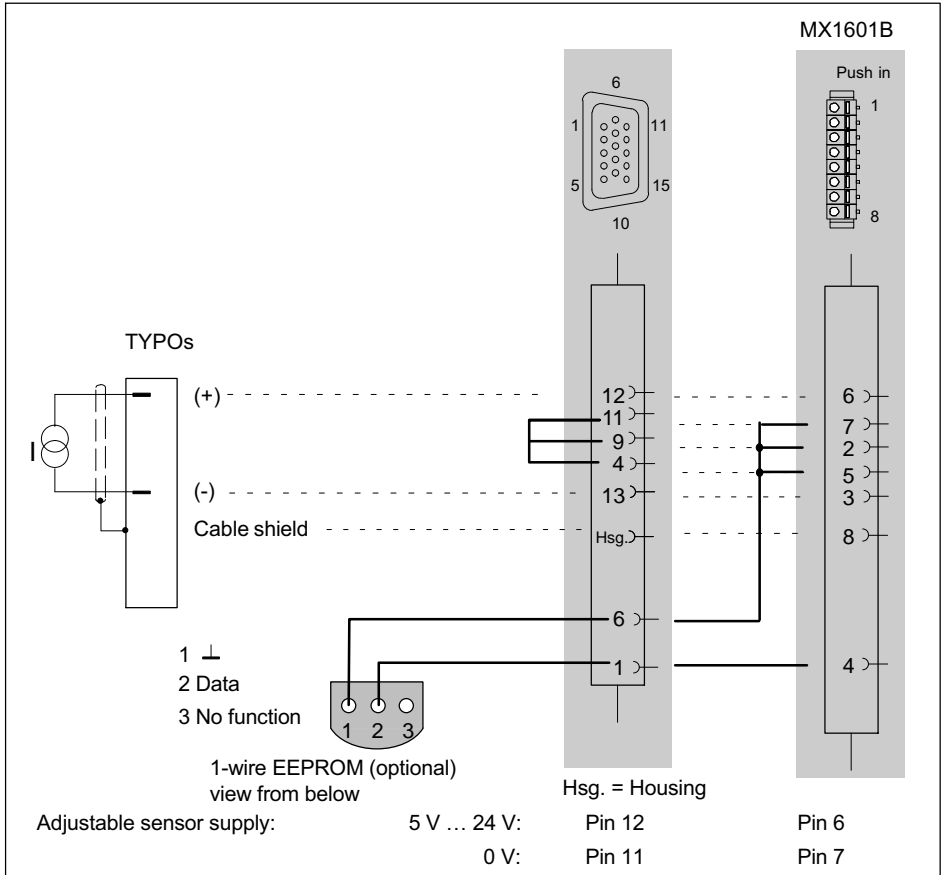

Maximum current ± 30 mA

The sensor supply must be connected in series. However, this eliminates the electrical isolation from the module supply for the affected channel.

9.18 Ohmic resistance (e.g. PTC, NTC, KTY, ...)

Supported by the following modules: MX840B, MX440B, MX1615B

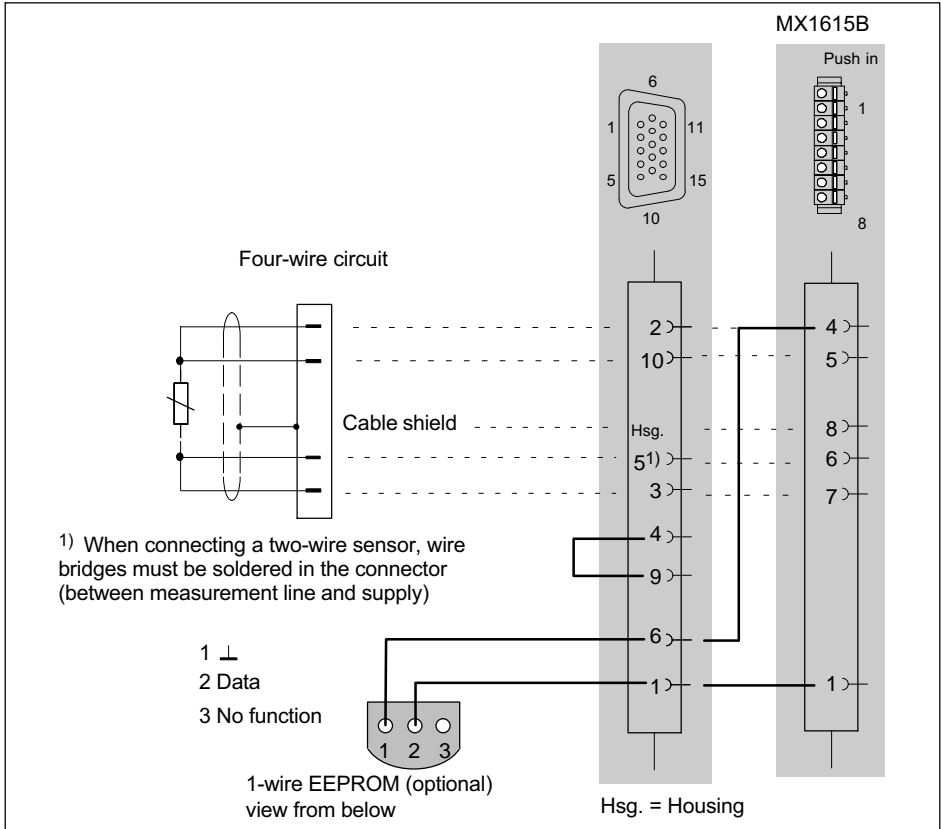

9.19 Resistance thermometer PT100, PT1000

Supported by the following modules:

PT100 / PT1000: MX840B, MX440BA

PT100: MX1615B

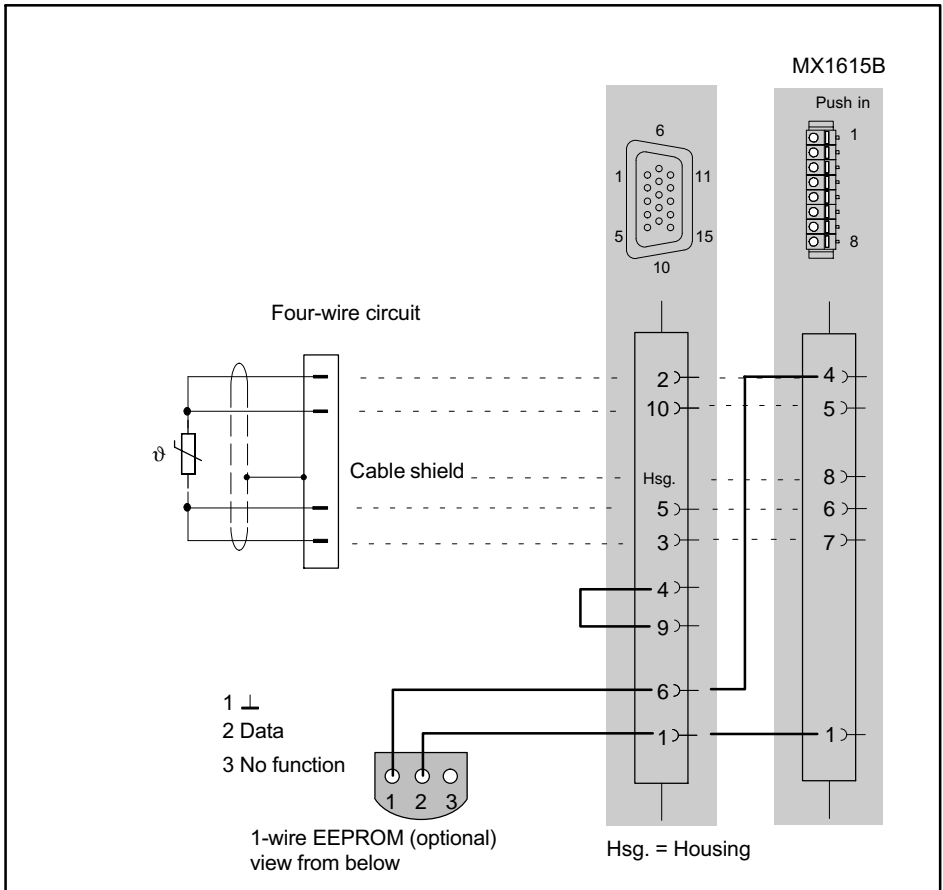

9.20 Thermocouples

Supported by the following modules: MX840B, MX440B, MX1609/KB, MX1609T/TB

The module MX1609/KB support only thermocouples type K; module MX1609T/TB supports type T (see page 105). In these modules, the required cold junction behind each socket is directly integrated in the module.

In the MX840B and MX440B, a small plug-in board (1-THERMO-MXBOARD) to act as a cold junction must be integrated into the SubHD plug (see next page).

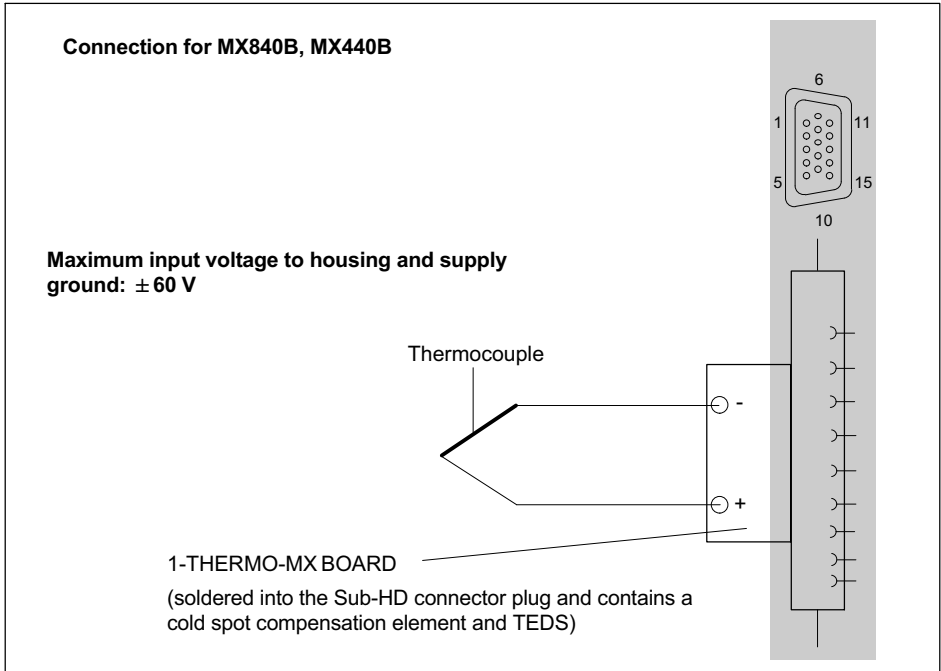

Type	Thermocouple material 1 (+)	Thermocouple material 2 (⊖)
J	Iron	Copper-nickel
K	Nickel-chrome (color code green)	Nickel-aluminum (color code white)
T	Copper	Copper-nickel

S	Rhodium-platinum (10%)	Platinum
I	Nickel-chrome	Copper-nickel
B	Rhodium-platinum (30%)	Rhodium-platinum (6%)
N	Nickel-chrome-silicone ¹⁾	Nickel-silicone
R	Rhodium-platinum (13%)	Platinum

1) Nicrosil

When recording temperatures with thermocouples with amplifiers MX840B or MX440B, you must solder the "1-THERMO-MX BOARD" board into the connector plug.

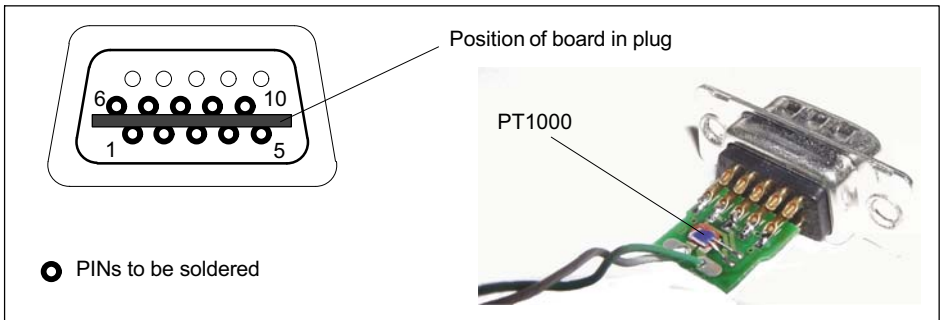

- Insert the 1-THERMO-MX BOARD in the correct position between the plug pins

Notice

*Check the position with the plug shape (see picture above).
In this position, the PT1000 of the cold spot compensation element is on top.*

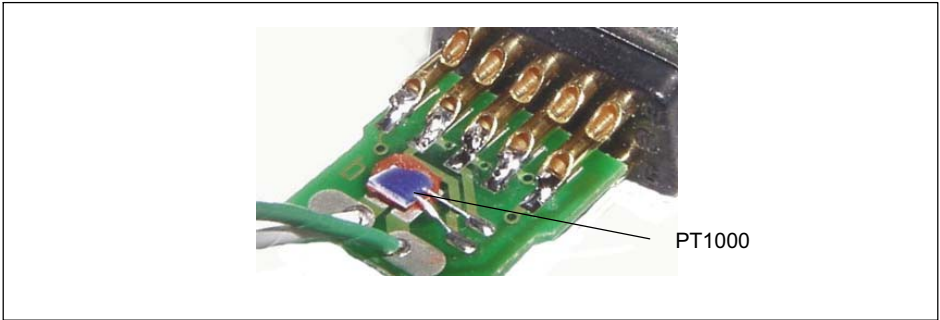

- Solder the connector pins to the connections on the board
- PIN 1 TEDS
- PIN 6 TEDS
- PIN 5 Thermocouple (+)
- PIN 10 Thermocouple (-)
- PIN 9 Signal ground
- PIN 7 PT1000 cold junction
- PIN 8 PT1000 cold junction
- PIN 2 Excitation (-)
- PIN 3 Excitation (+)

9.21 Frequency, differential, without directional signal

Supported by the following modules: MX840B, MX440B, MX460

NOTE

Maximum input voltage: 5 V to ground

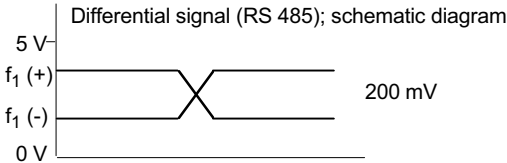

HBM torque transducer: Signal level: TTL only
Voltage supply: separate

Plug 1

Md

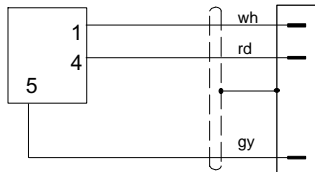

f₁ (-)

f₁ (+)

Cable shield

Shunt calibration

Ground

- 1 \perp
- 2 Data
- 3 No function

1-wire EEPROM (optional)
view from below

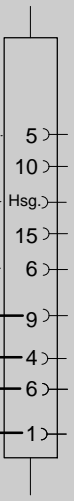
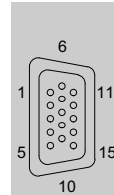

Hsg. = Housing

Adjustable sensor supply:

Pin12: 5 V ... 24 V;

0.7 W per channel, total 2 W.

Pin 11: 0 V

For further information see the data sheet.

Cable color code: wh= white; bk= black; bu= blue; rd= red; ye = yellow; gn= green; gy= gray

9.22 Frequency, differential, with directional signal

Supported by the following modules: MX840B, MX440B, MX460B

NOTE Maximum input voltage: 5 V to ground

Differential signal (RS 485); schematic diagram

5 V
 $f_1 (+)$
 $f_1 (-)$
 0 V

200 mV

HBM torque transducer: Signal level: TTL only
 Voltage supply: separate

Plug 2

bk and bu
 wh
 rd
 gn
 gy

Ground
 $f_1 (-)$
 $f_1 (+)$
 $f_2 (-)$
 Cable shield
 $f_2 (+)$

6
 5
 10
 7
 Hsg
 8
 9
 4
 6
 1

$f_1 (-)$ = Measurement signal speed, 0° (-)
 $f_1 (+)$ = Measurement signal speed, 0° (+)
 $f_2 (-)$ = Measurement signal speed, 90° (-)
 $f_2 (+)$ = Measurement signal speed, 90° (+)

1 \perp
 2 Data
 3 No function

1-wire EEPROM (optional)
 view from below

Hsg. = Housing

Adjustable sensor supply: Pin12: 5 V ... 24 V; 0.7 W per channel, total 2 W.
 Pin 11: 0 V For further information see the data sheet.

Cable color code: wh= white; bk= black; bu= blue; rd= red; ye = yellow; gn= green; gy= gray

9.23 Frequency, single-pole, without directional signal

Supported by the following modules: MX840B, MX440B, MX460B

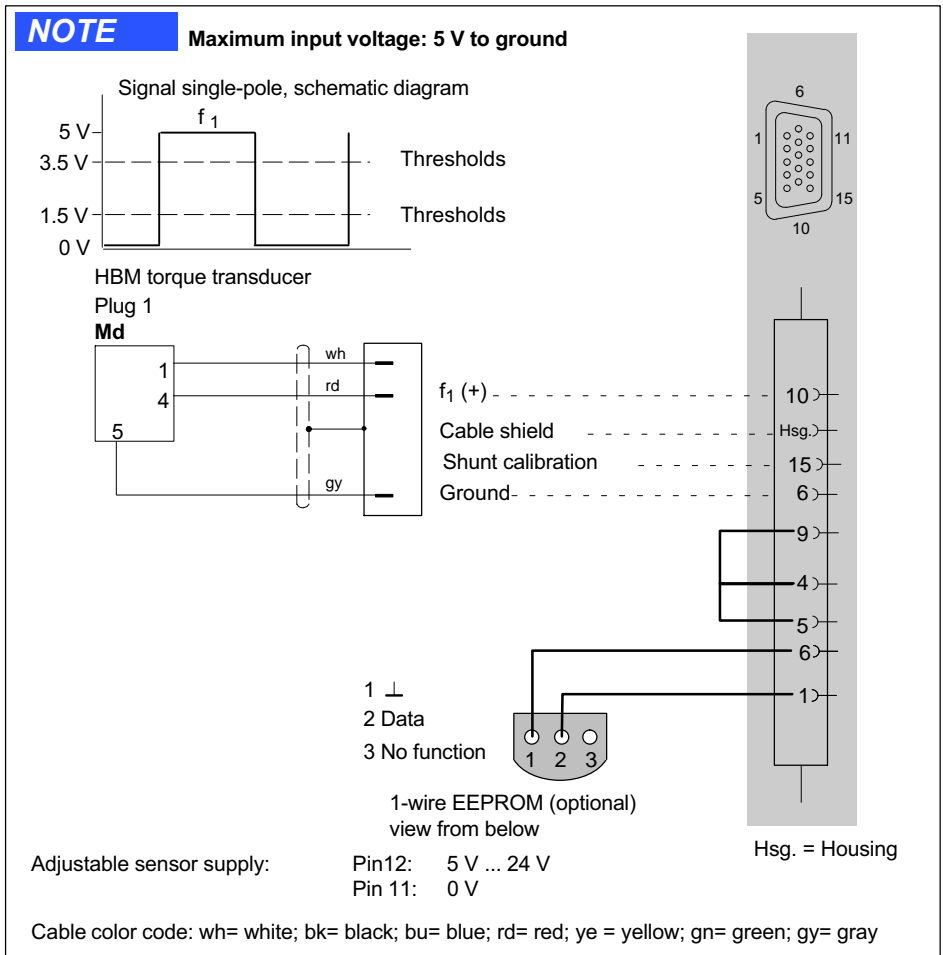

9.24 Frequency, single-pole, with directional signal

Supported by the following modules: MX840B, MX440B, MX460B

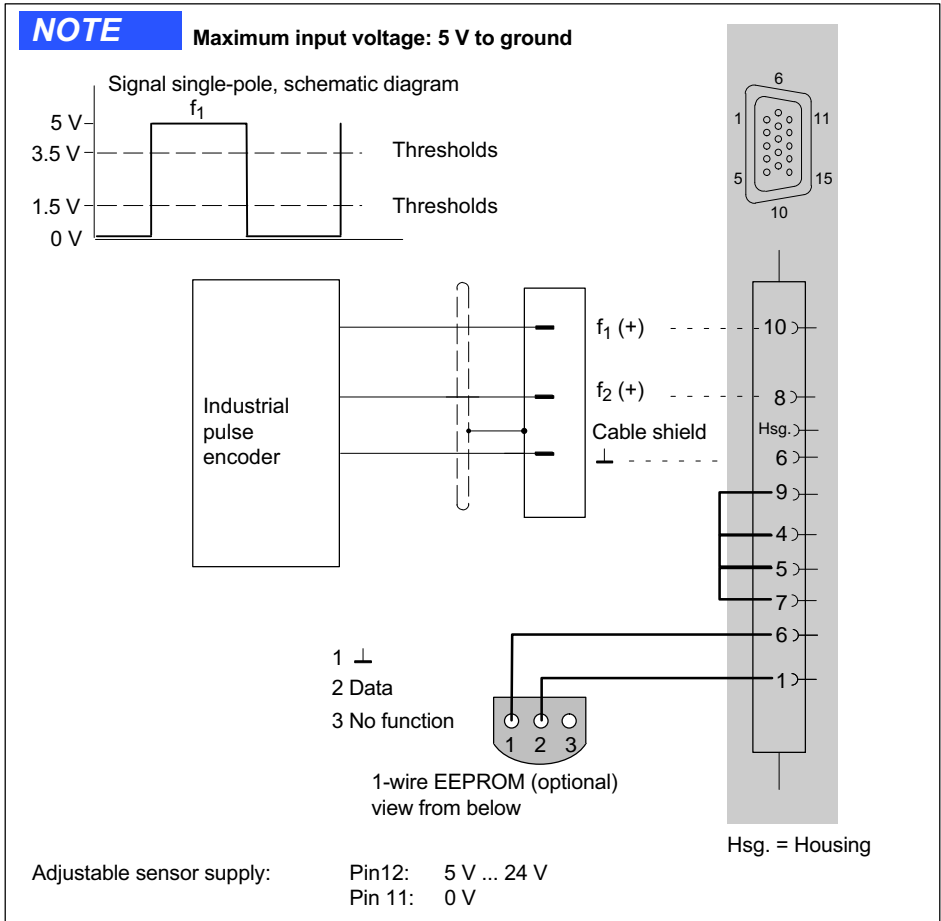

9.25 Encoder and pulse encoder, differential

Supported by the following modules: MX840B, MX440B, MX460B

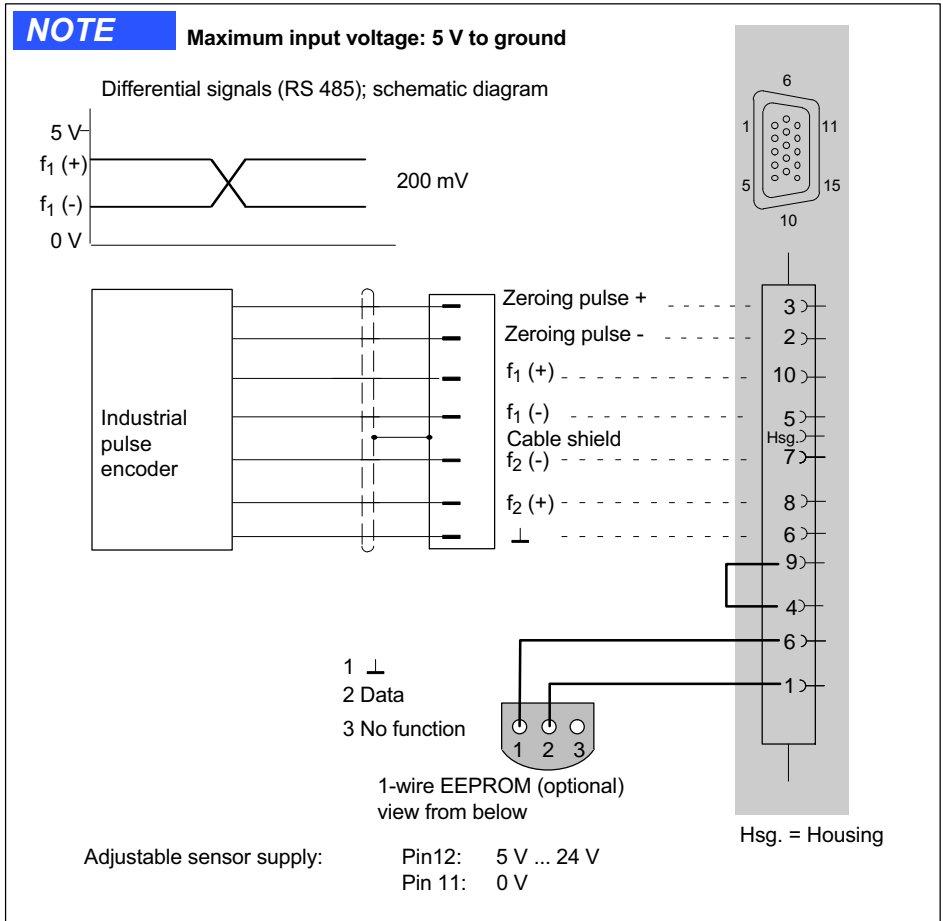

9.26 Encoder and pulse encoder, single-pole

Supported by the following modules: MX840B, MX440B, MX460B

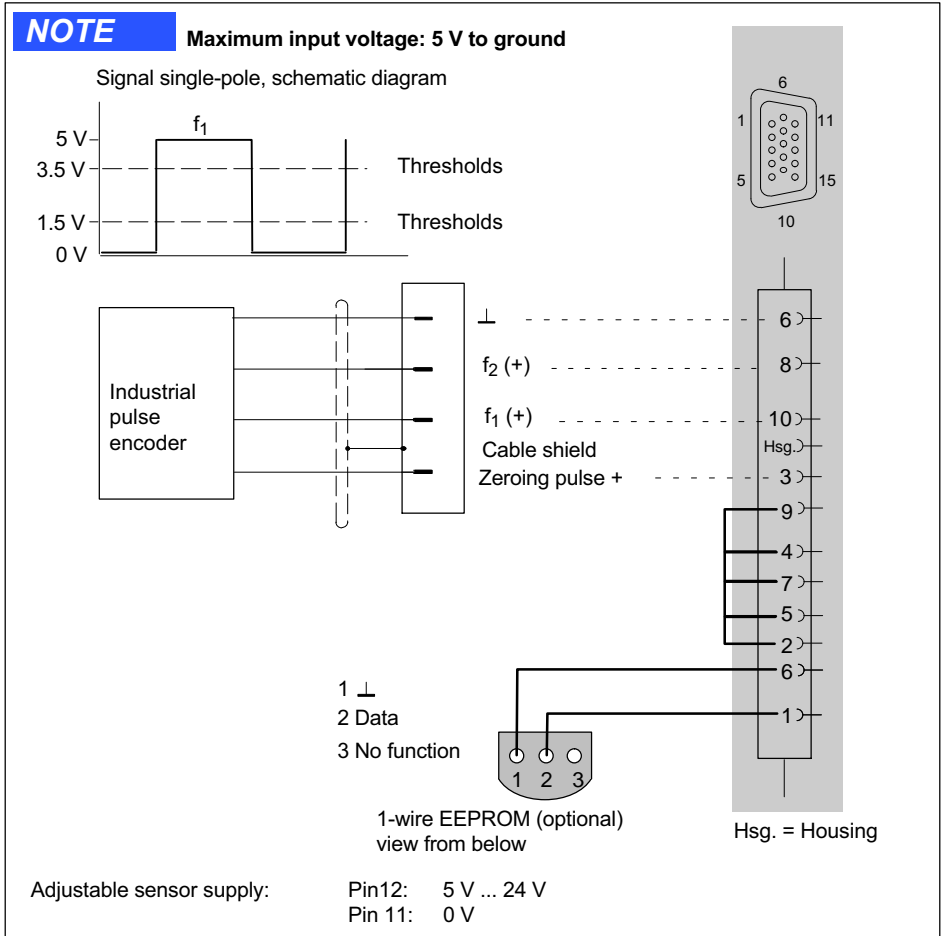

9.27 Rotary encoder and pulse generator, single pole with static directional signal

Supported by the following modules: MX840B, MX440B, MX460B

NOTE Maximum input voltage: 5 V to ground

Signal single-pole, schematic diagram

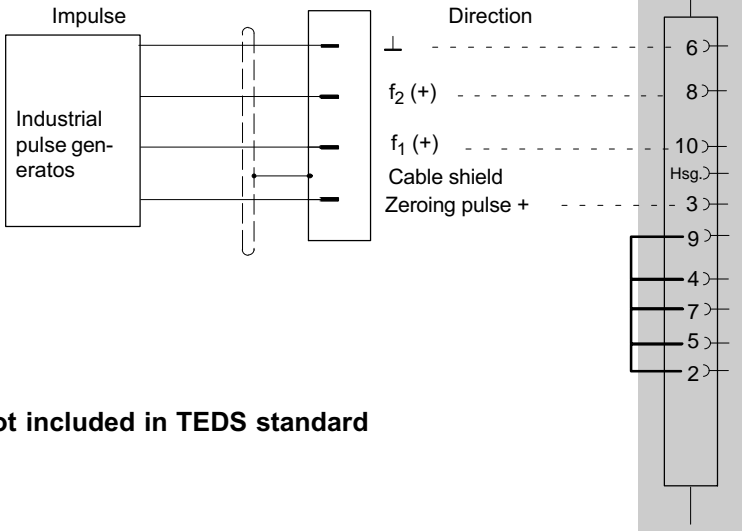
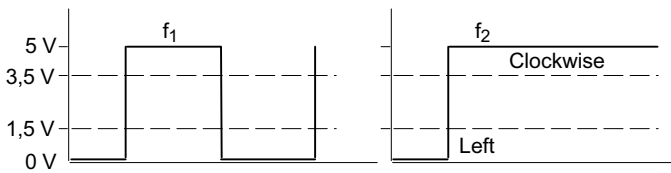

Not included in TEDS standard

Hsg. = Housing

Adjustable sensor supply: Pin12: 5 V ... 24 V
Pin 11: 0 V

9.28 Absolute value encoder with SSI protocol

Absolute value encoders provide information about position in the form of a digital numeric value. Because the numeric value is unique over the entire resolution range of the absolute value encoder, no initial reference movement is needed as is the case for incremental rotary encoders. Absolute values can be transferred by the encoder using the international SSI, EnDat (Heidenhain) or Hiperface (Sick-Stegmann).

In addition to the current position value, other data items can also be transferred. They can include current temperature values of the encoder or the electrical data of the servo motor on which the encoder is mounted (the "electronic rating plate")

Supported by the following modules: MX840, MX840B, MX440B

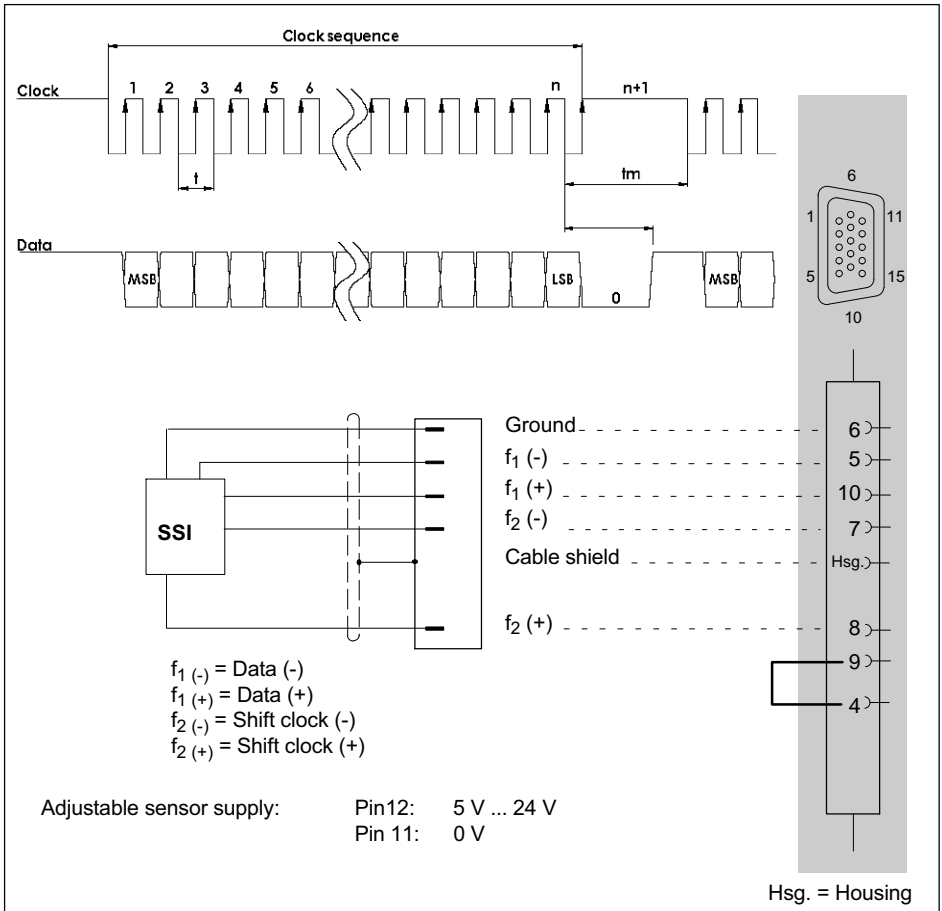

9.29 Passive inductive encoder (Pickups, Crankshaft sensor)

Supported by the MX460B module (only channel 1 and 2).

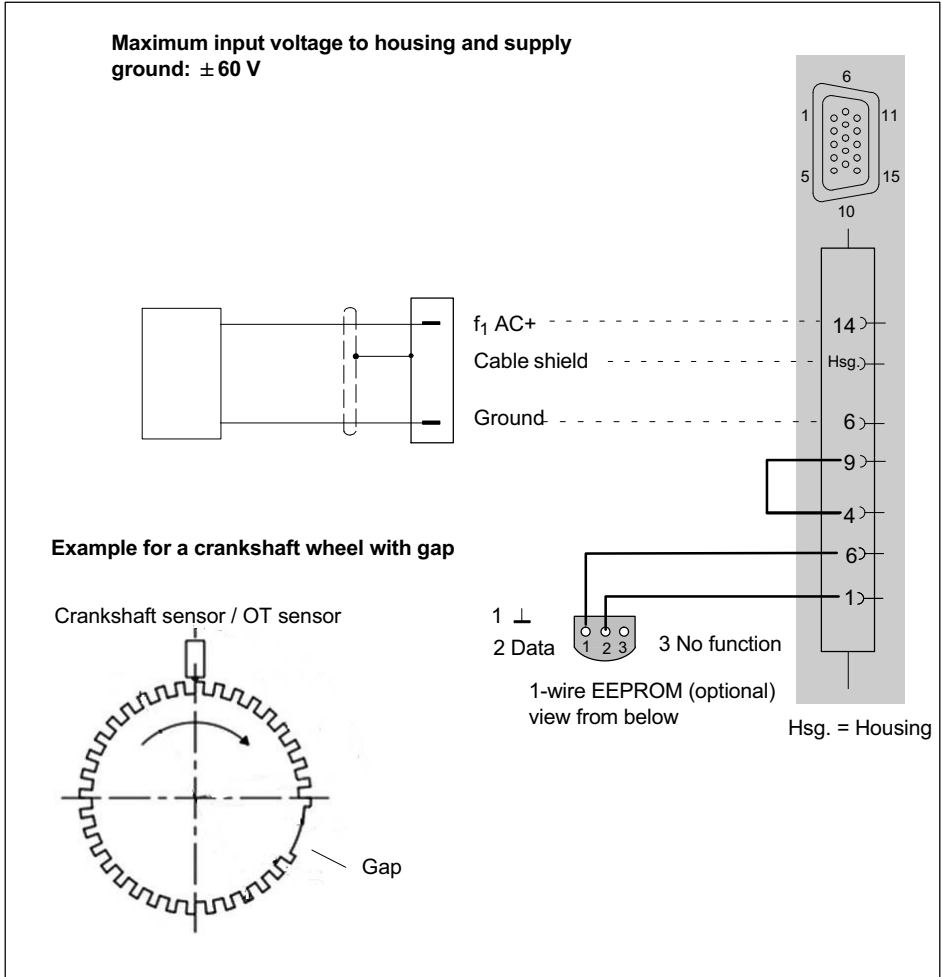

9.30 Measurement of rotational speed, Crankshaft sensor (digital, TTL)

Supported by the MX460B module: (only channel 1 and 2)

NOTE Maximum input voltage: 5 V to ground

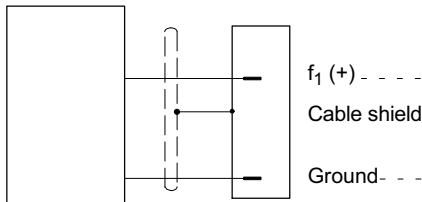
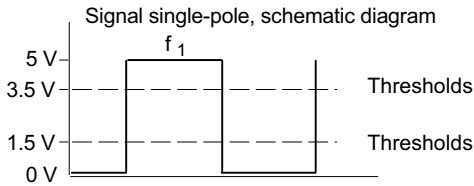

Example for a crankshaft wheel with gap

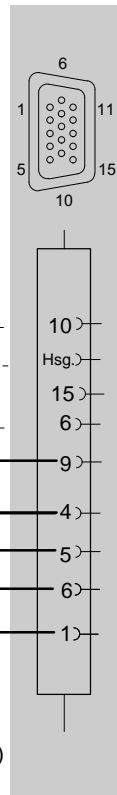
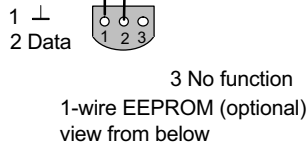
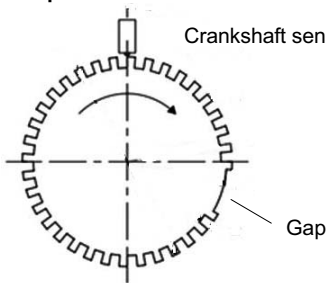

Hsg. = Housing

Adjustable sensor supply: Pin12: 5 V ... 24 V
Pin 11: 0 V

Cable color code: wh= white; bk= black; bu= blue; rd= red; ye = yellow; gn= green; gy= gray

9.31 PWM - Pulse width, pulse duration, period duration

Supported by the following modules: MX460B

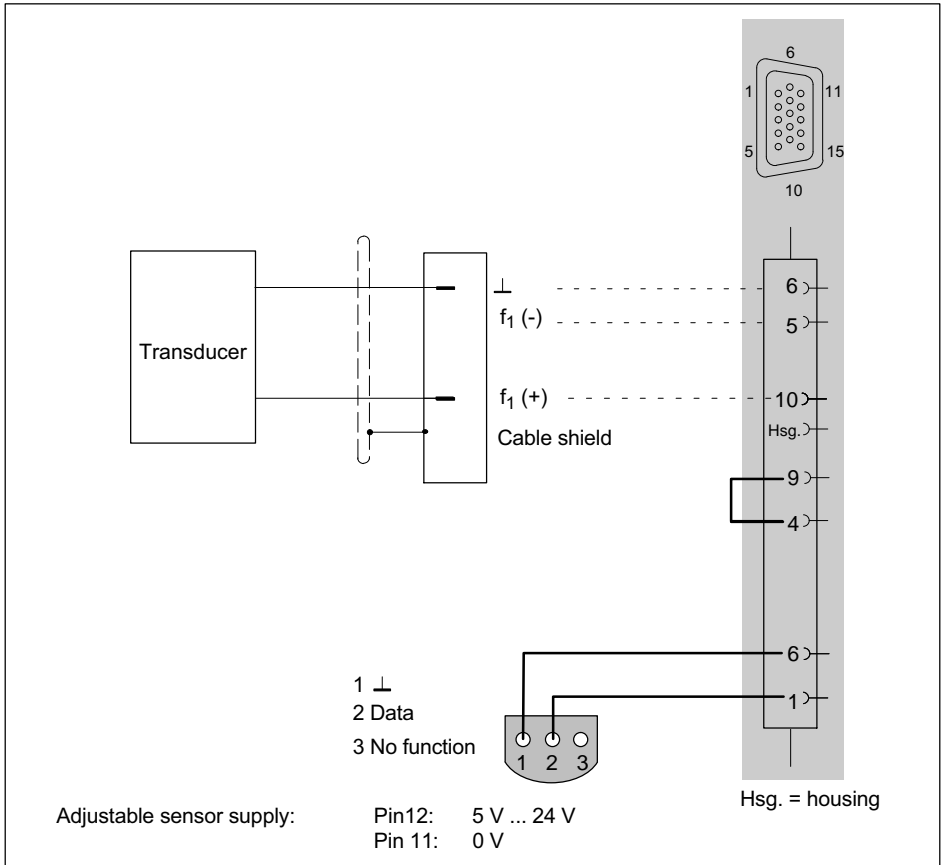

9.32 PWM - Pulse width, pulse duration, period duration, single-pole

Supported by the following modules: MX460B

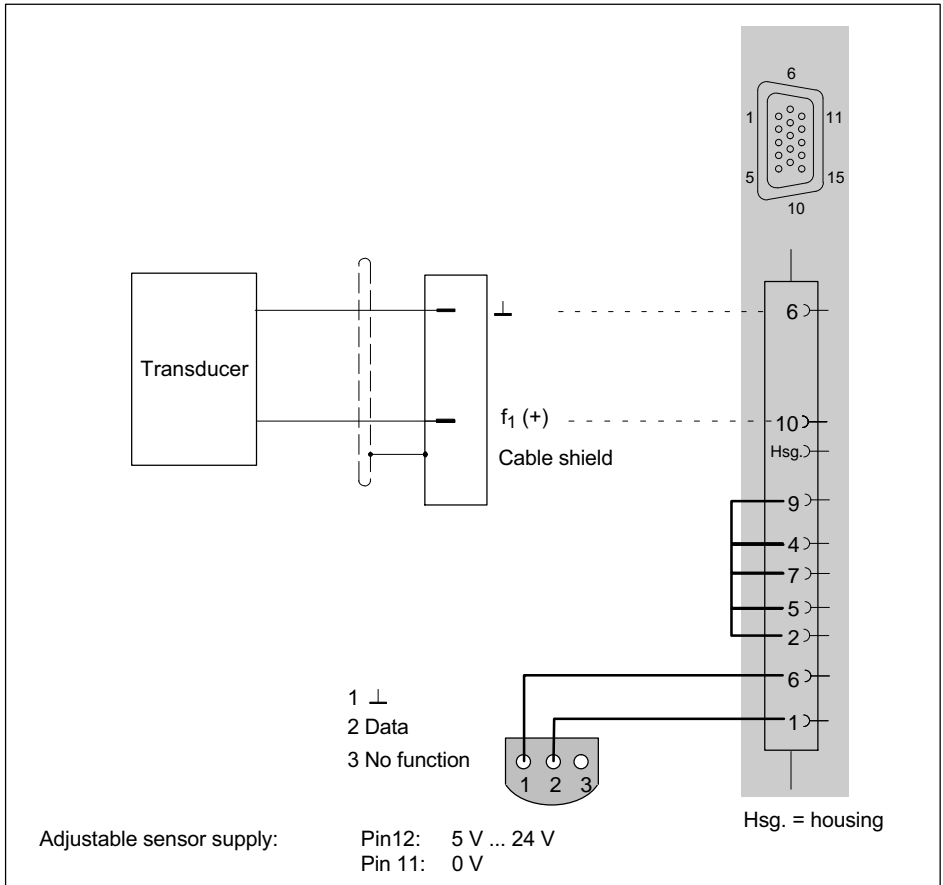

9.33 CAN bus

Receiving CAN signals:
 MX471B/C, MX840B (channel 1)

Transmitting CAN signals:
 MX471B, MX840B (channel 1, measurement signals within the module only)

Receiving CCP or XCP-over-CAN signals:
 MX471B

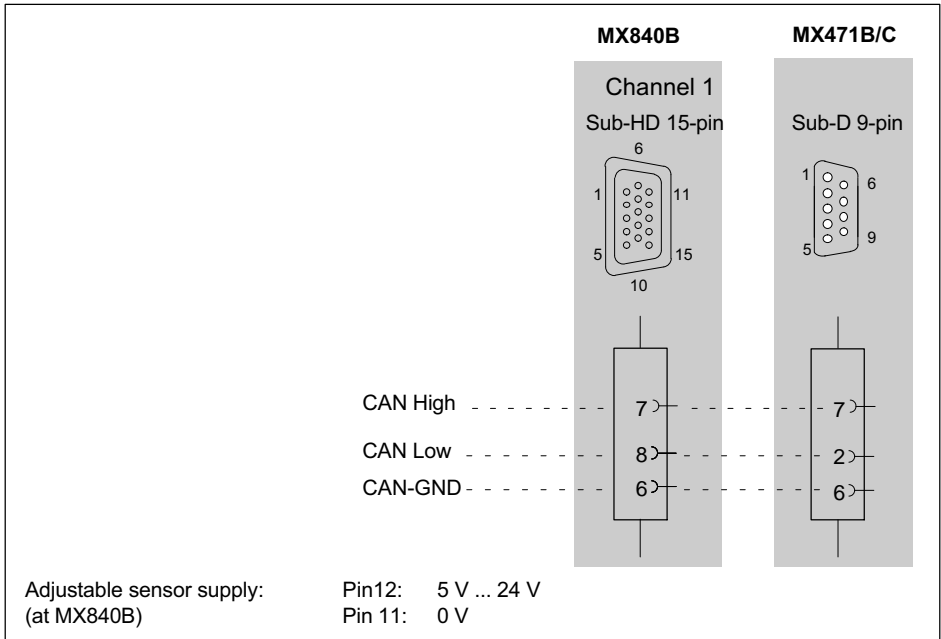

Notice

Ensure correct termination with termination resistors is made, as shown in Fig. 9.1. The MX840B does not have any termination. The MX471B/C has internal termination that can be activated via software.

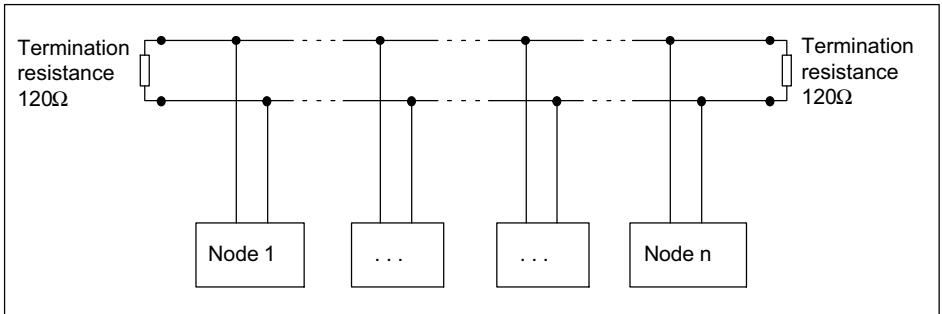

Fig. 9.1 Bus termination resistors

10 Functions and outputs

The MX410B, MX430B, MX460B as well as MX878B, MX879B modules can perform calculations in real time, with the results available as *standard system signals*. These system signals can be used like actual measurement signals for subsequent tasks (analog output, EtherCAT® signal, source signal for mathematics function, data visualization and storage).

The MX878B, MX879B MX410B and MX430B modules feature analog outputs that can be connected to a system or source signal, for example an actual measurement signal (additionally scaled, filtered) or the result of a mathematics function. In addition, MX879B provides digital inputs and outputs (binary, static). The digital inputs are time-stamped. Some digital outputs can be activated in real time by limit switch.

Measurement channels that are used in mathematics functions or directly for analog outputs need to be activated for *"isochronous data transfer"* (for example in the QuantumX Assistant software, "Signals" tab).

Notice

The module configuration is immediately active after system reboot (Auto Startup). No operating PC is required for configured signal outputs to run standalone.

Realtime functions overview

Module	Peak values	Add and multiply	Root Mean Square (RMS)	Rotation and angular difference	PID controller	Matrix	Signal generator	Limit value switch
MX410B	x		x					
MX403B	x		x					
MX430B						x		
MX460B	x			x				
MX878B	x	x	x		x	x	x	
MX879B	x	x	x		x	x	x	x

10.1 Amplifier with analog outputs

Modules such as MX410B or MX430B provide one analog output each per measurement channel that is accessible via a BNC socket on the front.

The outputs are directly assigned to the inputs located above them.

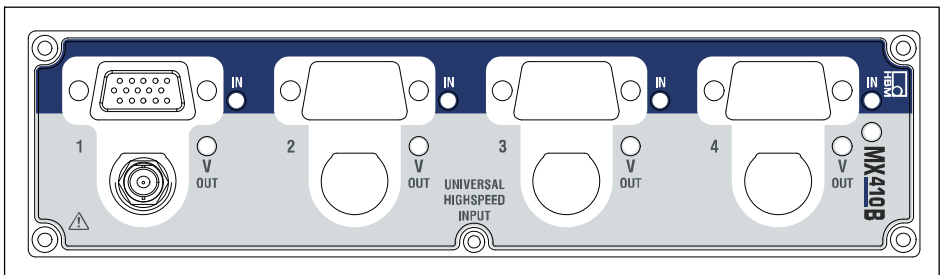

Fig. 10.1 MX410B front view

Notice

After an analog output is configured, its function (configuration, scaling) continues to be available even if the computer is disconnected. Therefore no connection to a PC is required.

Specifically MX410B supports furthermore 8 peak value detection channels and 4 RMS channels.

These functions can be used to generate so-called virtual signals that can also be output at the analog output and made available to the QuantumX system. This also makes the signals visible to the software.

The device is parameterized by means of the software (e.g. QuantumX Assistant or catman®AP).

Keep in mind the following notes when working with peak value monitoring channels:

- The maximum output (sampling rate) is restricted to 4800 Hz
- PEAK values can only be reset via PC software (system signals will follow)
- The output rate of the peak value monitoring channel must not be higher than the sampling rate of the input channel.
- Filters set for the MX410B do not apply to peak value monitoring channels
- These channels are always unfiltered. However, the input signal is filtered.
- The peak value units do not accept other peak value units or RMS as input. Only the 4 analog inputs are allowed.

Peak value function

Each peak value detection unit can monitor either the Min peak or the Max peak of one of the module's 4 analog input channels. A peak value unit may operate in different modes:

- EXPORT: peak values will be continuously updated
- HOLD: last peak value will be "frozen"
- PEAK VALUE: peak value detection enabled

- FOLLOW: peak value detection disabled, i.e. the channel returns the original signal of the input channel

The following combinations are possible:

- RUN MAX PEAK VALUE
- HOLD MAX PEAK VALUE
- FOLLOW HOLD MAX

This also applies to minima.

Graph for the peak value function

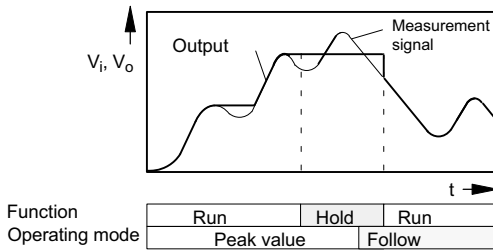

Function for Root Mean Square (RMS) calculation

RMS is computed from one of the module's 4 analog input channels according to the formula:

$$RMS = \sqrt{\frac{1}{T} \int_0^T f(x)^2 dx}$$

Where $f(x)$ denotes the input channel signal and T the time window (in ms).

Keep in mind the following notes when working with RMS channels:

- The maximum sampling rate is 4800 (2400) Hz
- The output (sampling) rate of the RMS channel must not be higher than the sampling rate of the input channel.

- Filters set for the MX410B do not apply to RMS channels. These channels are always unfiltered. However, the input signal is filtered.

10.2 MX460B

The MX460B supports 4 special math channels for analysis of rotational parts: Rotational vibration and angle difference.

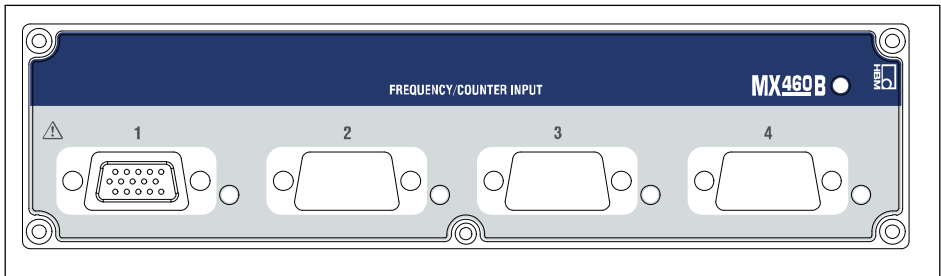

Fig. 10.2 MX460B front view

MX460B math channels

Keep in mind the following notes when working with these channels:

- The maximum sampling rate is 4800 (2400) Hz
- The sampling rate of the channel must not be higher than the sampling rate of the input channel.
- Filters set for the MX460B do not apply to math channels. These channels are always unfiltered.

However, the input signal is filtered.

10.3 MX878B

The MX878B module is a module with eight analog outputs that can be accessed on the front panel via BNC sockets or plug terminals.

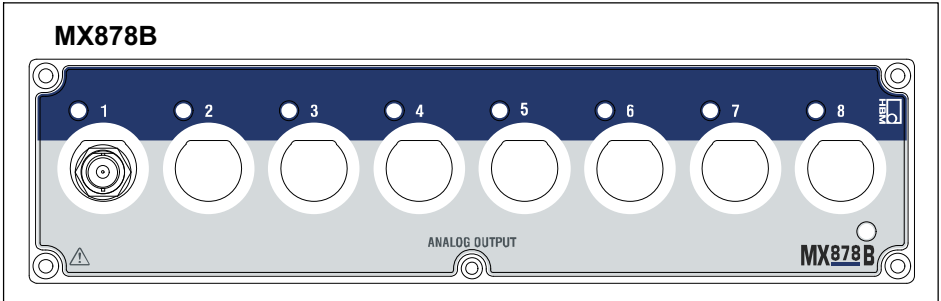

Fig. 10.3 MX878B front view

Two analog outputs each (1 and 2, 3 and 4, etc.) have the same ground potentials, for the others electrical isolation applies between them and the voltage supply ground.

The modules can receive all signals that are isochronously available on the IEEE1394b FireWire.

The settings for this are implemented with the QuantumX Assistant. Before output at the analog output, the signal passes through an output characteristic curve parameterized by the user (2-point scaling) and a filter also parameterized by the user. In addition, the rate for DAC is reduced to 96 kS/s through interpolation.

Math channels

The MX878B is a dedicated module designed for analog outputs and math channels.

The MX878B supports 4 math channels and peak value detection channels.

In contrast to other modules, the MX878B has no analog sensor inputs. Instead it receives data from other modules via the "isochronous IEEE1394b FireWire transfer" from any source within the system configured for this data transfer mode. The module routes this data to an analog output or performs a

math computation on this data (which may also be output on one of the analog outputs).

You need to connect all modules via IEEE1394b FireWire (or use a backplane) for the MX878 to become operational! You can configure several channels to "isochronous IEEE1394b FireWire transfer" using QuantumX Assistant software or catman@AP 3.1 or higher.

Please note:

Providing the data via isochronous transfer may use up significant computing power on the module (in particular on the MX410B module and the MX460B high-speed module). Do not activate the isochronous data transfer unless it is actually needed!

Add & Multiply functions

The MX878B currently provides the following type of computation:

$$\begin{aligned} \text{Result} = & a_0 + a_1 * \text{InputSignal1} + \\ & a_2 * \text{InputSignal2} + \\ & a_3 * \text{InputSignal1} * \text{InputSignal2} \end{aligned}$$

Where InputSignal1 and InputSignal2 denote the two input signals used for this computation.

These channels will reside on other modules and must have their isochronous IEEE1394b FireWire transfer enabled.

Keep in mind the following notes when working with math channels:

- The maximum sampling rate is 2400 Hz
- The sampling rate of the channel must not be higher than the sampling rate of the input channels.
- Filters do not apply to math channels. These channels are always unfiltered.

Matrix computation function

The MX878B makes it possible to perform 4 parallel matrix computations each with a maximum of 6 input and output quantities and 36 constants.

Generic formula:

$F_x = a_1 \cdot U_{fx} + a_2 \cdot U_{fy} + a_3 \cdot U_{fz} + a_4 \cdot U_{mx} + a_5 \cdot U_{my} + a_6 \cdot U_{mz}$
 etc. for F_y , F_z , M_x , M_y , M_z

The "Matrix computation" function can be used for mathematical compensation of interdependencies (crosstalk) of multi-component transducers for force and torque measurement.

The maximum data rate of the input and output quantities is 1200 Hz (< 1 ms of computation time). The computed output signals can be scaled and output as filtered analog voltages by the same module. The computed signals can also be distributed (isochronously) to the IEEE1394b FireWire bus in real time and output via CAN bus or EtherCAT® (MX471B: CAN bus. MX878B: EtherCAT® bus).

Scaling of the input and output quantities must always be noted.

An EXCEL compensation matrix can be copied directly to the matrix parameterization (Ctrl + C, Ctrl + V).

Function for Root Mean Square (RMS) calculation

RMS is computed from one of the module's 4 analog input channels according to the formula:

$$RMS = \sqrt{\frac{1}{T} \int_0^T f(x)^2 dx}$$

Where $f(x)$ denotes the input channel signal and T the time window (in ms).

Keep in mind the following notes when working with RMS channels:

- The maximum sampling rate is 4800 (2400) Hz
- The output (sampling) rate of the RMS channel must not be higher than the sampling rate of the input channel.
- Filters set for the MX878B/879B do not apply to RMS channels. These channels are always unfiltered. However, the input signal is filtered.

Peak value function

Keep in mind the following notes when working with peak value monitoring channels:

- The maximum sampling rate is 4800 Hz
- The sampling rate of the channel for peak value monitoring must not be higher than the sampling rate of the input channel.
- The peak value units do not allow for any other peak value units or RMS values as input

Each peak value detection unit can monitor either the Min peak or the Max peak of one of the four signals within the system identified as "isochronous".

A peak value unit may operate in different modes:

- EXPORT: peak values will be continuously updated
- HOLD: last peak value will be "frozen"
- PEAK VALUE: peak value detection enabled
- FOLLOW: peak value detection disabled, i.e. the channel returns the original signal of the input channel

The following combinations are possible:

RUN MAX PEAK VALUE

HOLD MAX PEAK VALUE

FOLLOW HOLD MAX

This also applies to minima.

Graph for the peak value function

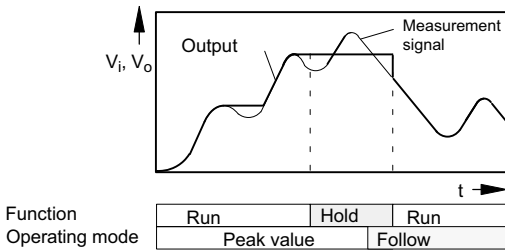

Analog outputs of the MX878B

The MX878B is a dedicated module designed for analog outputs and math channels. In contrast to other modules, the MX878B has no analog sensor inputs. Instead it receives data from other modules via the "isochronous IEEE1394b FireWire transfer". The module then routes this data to an analog output.

You need to connect all modules via IEEE1394b FireWire (or use a backplane) for the MX878B to become operational! Please note the "ISO" column in the catman® channel configuration window. This column indicates if a channel provides its data via the isochronous link (indicated by a symbol). Click the column or use the column's context menu to enable or disable isochronous transfer for a channel.

Providing the data via isochronous transfer may use up significant computing power on the module (in particular on the MX410B module and the MX460B high-speed module). Do not activate the isochronous data transfer unless it is actually needed!

MX878B signal generator

The MX878B has 8 signal generators. The signals (e.g. set profiles for controlling uni- or multi-axial actuators) can be individually generated and assigned to analog outputs.

The following signal forms are available (to be defined in an ASCII file):

constant, sine, rectangle, triangle

Depending on their type, the signal forms are described by the following parameters:

level, frequency, duty ratio

The signals are buffered and described as follows:

Repetition cycle (continuous, triggered)

Point in time

A buffer that has been filled before can be output with a defined number of repetition cycles, continuously and triggered, starting at a specific point in time.

In addition, a second buffer is available. While one buffer is output the second buffer can be filled. Output of the second buffer can be activated immediately or when the first buffer has been output. At the end of the sequence, the last output value is held.

PID controller

The PID controller function block allows setup of a controller with proportional, integrating and differential share with limiting component and anti-windup. Signals can be assigned to measured or actual value as well as setpoint value.

Parameter

Gain, K_p , P component

Reset time T_i [seconds], I component

Rate time T_d [seconds], D component

Upper limit of the controller output y_{max}

Lower limit of the controller output y_{min}

Additional value input: as fix output value

Default output: default is output when Enable input = low

10.4 MX879B Multi-I/O module

The MX879B module is a multi-I/O module with eight analog outputs and 32 digital I/Os that can be accessed on the front panel via plug terminals.

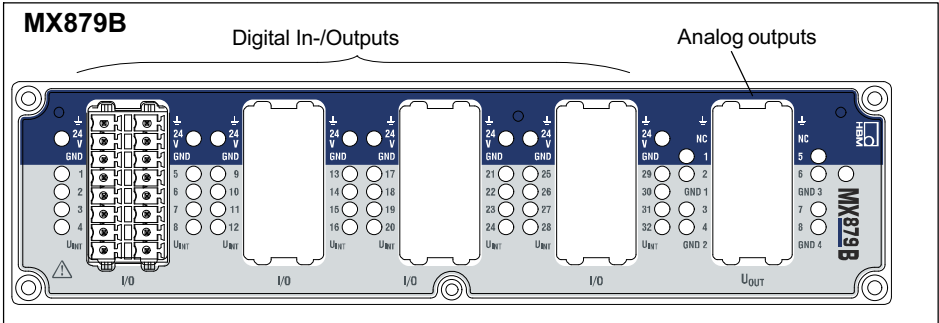

Fig. 10.4 MX879B front view

Two analog outputs each (1 and 2, 3 and 4, etc.) have the same ground potentials, for the others electrical isolation applies between them and the voltage supply ground.

The modules can receive all signals that are isochronously available on the IEEE1394b FireWire.

The settings for this are implemented with the QuantumX Assistant. Before output at the analog output, the signal passes through an output characteristic curve parameterized by the user (2-point scaling) and a filter also parameterized by the user. In addition, the rate for DAC is reduced to 96 kS/s through interpolation.

The MX879B functions are similar to those of the MX878B.

In addition, the MX879B offers a *limit value monitoring function*.

Limit value monitoring

The limit value unit consists of eight limit value switches for monitoring of eight signals. Any signal that is available throughout the system can be used as the input signal.

The logic output can be assigned to a digital output. Parameterization includes the input signal and, in addition, the switching threshold, hysteresis, switching logic and output logic.

The update rate of limit values is 4800 Hz.

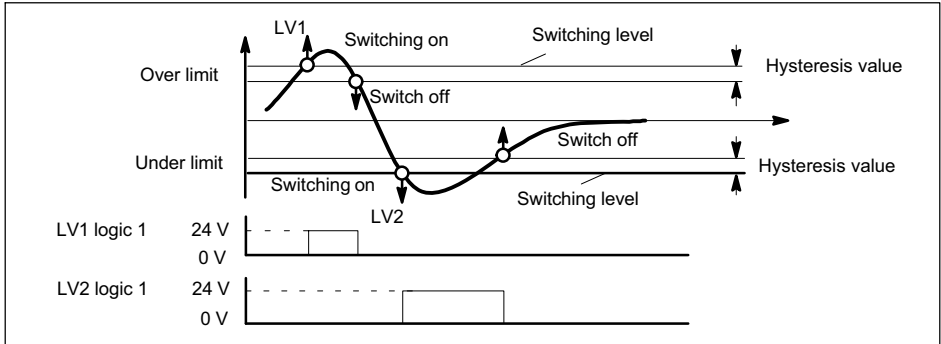
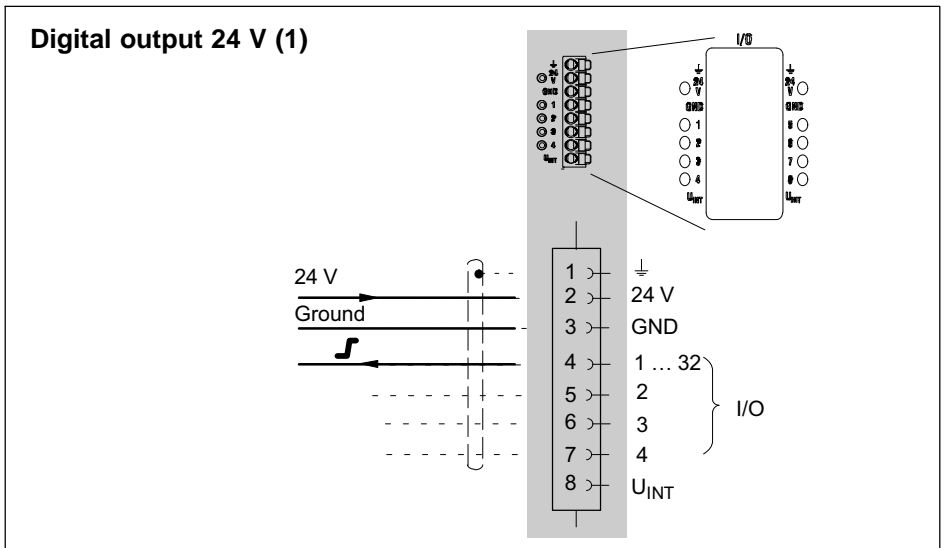
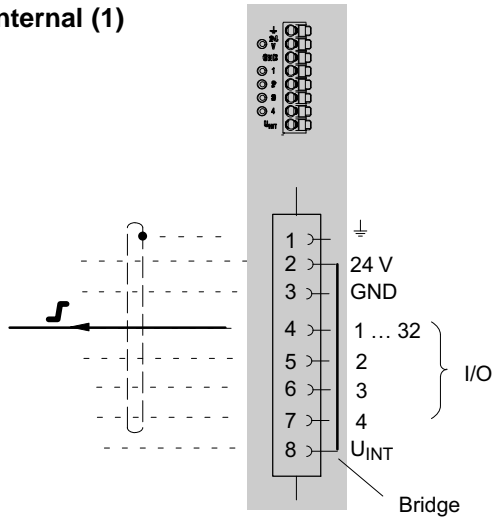

Fig. 10.5 Limit value functions and parameters

Examples of connections for MX879B



Digital output 5 V, internal (1)



Digital input 24 V (1)

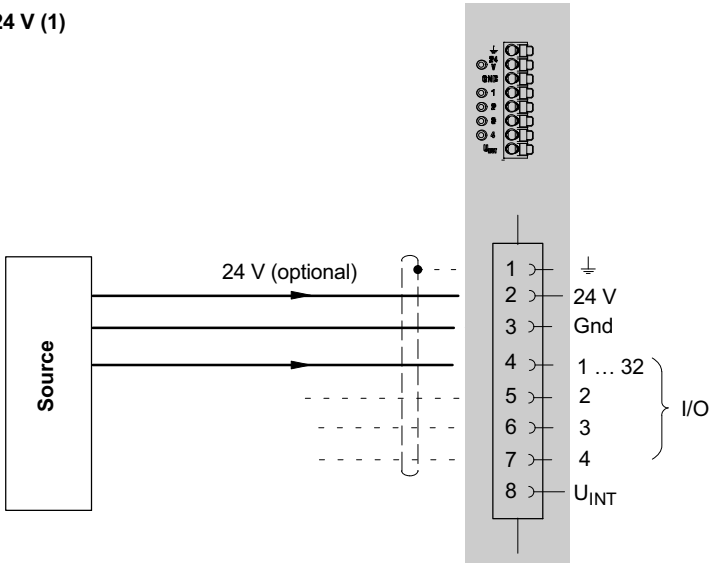

Note:

Each twin unit comes with one power supply.

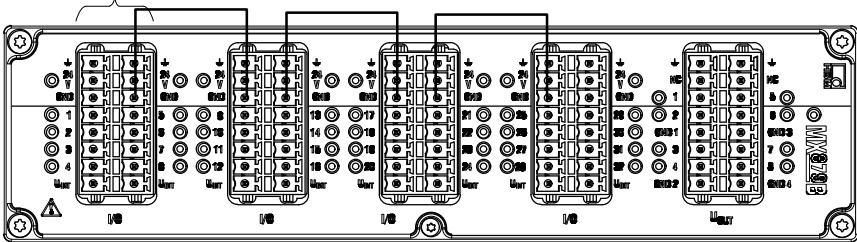

To supply all I/Os with power, bridging is required or each twin unit needs to be powered separately.

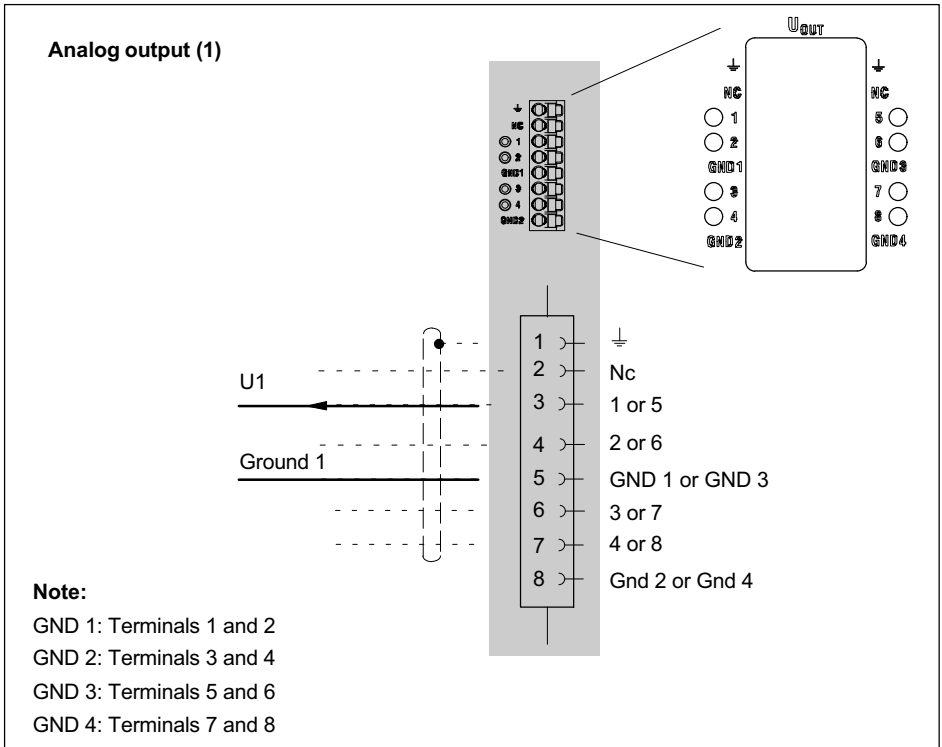

Notice

The analog output sockets are coded. The push-in plugs need to be prepared accordingly.

Coding of the *analog output sockets*:

Analog output sockets are coded for protection.



A tip needs to be cut off when preparing plug connections for analog outputs (coding).



10.5 MX471B

The MX471B module ensures a high-performance connection between a CAN bus network and the QuantumX system.

Four CAN interfaces are available, all working independently of each other.

The measurement system can read in CANbus signals and also output them

The “QuantumX CANbus” operating manual explicitly describes all matters concerning the bus and the modules.

11 FAQ

Subject

QuantumX in an (Ethernet) network and DeviceScan with catman@Easy/AP

Question/Problem

I connected a QuantumX amplifier via a network cable and started the catman@EASY/AP software, but I am not getting a connection to the amplifier.

The software advises:

"The device scan cannot find any connected devices. ..."

Reply/Solution

- First of all, check carefully whether the network address of the QuantumX amplifier is in the same subnet as the PC and whether this IP address is correctly entered in the scan options of catman@Easy/AP. If this is the case, the following factors may also prevent the QuantumX from being located in the network:
- Check that the Ethernet cable is plugged in
- The Windows® firewall. This can block the connection during device scanning and should be switched off temporarily for the duration of the measurement. The settings for the firewall can be found under **Control panel** –> **Security center** –> **"Windows Firewall"**.
- Wireless network adapters (WLAN). These can, depending on the configuration, take priority in operating the network and thereby disturb the wired network scan. If a WLAN adapter is present on the notebook or laptop, it must be deactivated.
- The firewall of an installed VPNClient. This can also disturb a network scan. For example, the setting "Stateful Firewall (Always On)" is activated by default in the CISCO VPN Client. This should be temporarily deactivated for the QuantumX device scan.
- A virus scanner can also possibly block the network scan due to its properties. It should therefore be temporarily deactivated.

- If the PC settings will not permit a scan via a network area at all (e.g. for security reasons), it is still possible to connect a device manually with a selected configuration (from catman@EASY/AP version 2.2). This setting can be found in the "Scan options" as the option "Add device manually".

Please note that administrator rights under Windows® may be necessary for some of these settings.

Question/Problem

How can I quickly check whether or not I can actually communicate with the amplifier?

Reply/Solution

Windows Start -> Search and start "cmd" and enter the following at the C:> prompt:

```
ping xxx.xxx.xxx.xxx (ENTER)
```

The xxx.xxx.xxx.xxx represents the IP address of your QuantumX device. If correctly connected, the device will reply positively. An example is shown in the following screenshot:

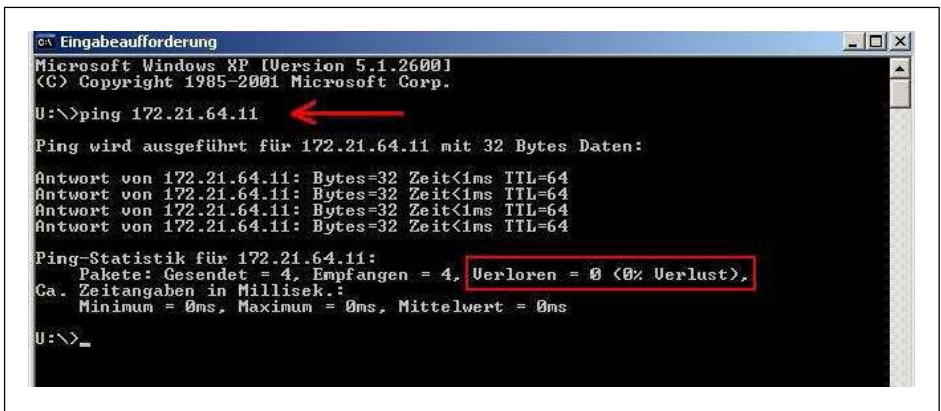

```

Eingabeaufforderung
Microsoft Windows XP [Version 5.1.2600]
(C) Copyright 1985-2001 Microsoft Corp.

U:\>ping 172.21.64.11
Ping wird ausgefuehrt fuer 172.21.64.11 mit 32 Bytes Daten:

Antwort von 172.21.64.11: Bytes=32 Zeit<1ms TTL=64
Antwort von 172.21.64.11: Bytes=32 Zeit<1ms TTL=64
Antwort von 172.21.64.11: Bytes=32 Zeit<1ms TTL=64
Antwort von 172.21.64.11: Bytes=32 Zeit<1ms TTL=64

Ping-Statistik fuer 172.21.64.11:
    Pakete: Gesendet = 4, Empfangen = 4, Verloren = 0 <0% Verlust>.
    Ca. Zeitangaben in Millisek.:
        Minimum = 0ms, Maximum = 0ms, Mittelwert = 0ms

U:\>_
  
```

If no module appears, there are several possible causes. Check the following points and then repeat the search.

- Have you activated the correct interface or correct interface adapter?

- Check the Scan options in the 'Module suchen' dialog.
- Does your Ethernet switch work properly?

If you are not operating any other devices on the switch with which you can check the function, try to set up a direct connection between the PC and the QuantumX module.

- If you want to use the QuantumX module in a larger network, please contact your network administrator. There are a series of options in administrated networks to limit or completely prevent data transmission between individual subscribers. Administrative enabling may also be necessary here.

Operation in LAN

1. No server in the network, the PC has no setting or uses DHCP, the QuantumX module has a permanent address

No connection can be set up with this combination.

2. DHCP server in the network, the PC has a permanent address or uses DHCP, the QuantumX module has a permanent address

A connection can normally only be set up when the PC and QuantumX module addresses lie in the same subnet, i.e. the IP address may only have different digit groups where a 0 is present in the subnet mask. Also refer to *Changing the Ethernet interface parameters of the QuantumX_*

12 Accessories

System accessories

Article	Description	Order no.
Backplane QuantumX (standard)	Backplane for maximum 9 modules of the QuantumX family. General information: - Wall or control cabinet installation (19"); - External modules can be connected via IEEE1394b FireWire; - Power supply: 24 V DC; - Power consumption: Max 5 A (150 W); Note: Only modules with protection class IP20 can be inserted.	1-BPX001
QuantumX Backplane	QuantumX Backplane-Rack for maximum 9 modules in IP 20: - 19" rack mounting with handles left and right; - Connection of external modules via FireWire possible; - Power supply: 24 V DC / max. 5 A (150 W)	1-BPX002

Module accessories

Voltage supply		
	Description	Order no.
Power supply	AC/DC power supply unit; input: 100-240 V AC ($\pm 10\%$); 1.5 m cable with international plug set Output: 24 V DC, Max. 1.25 A; 2 m cable with plug for IP20 modules.	1-NTX001
Voltage supply, open line	3 m cable for voltage supply of a QuantumX module. Plug for IP20 modules on one side and exposed wires at the other end. Note when using multiple modules: The supply voltage can be looped through IEEE1394b FireWire connections (max. 1.5 A).	1-KAB271-3
Mechanical		
	Description	Order no.
Housing connection element for QuantumX modules, see <i>section 6, page 37</i>	Mechanical connection elements for QuantumX modules (IP20 / IP65). Set consisting of 2 case clips, including assembly material for fast connection of 2 modules.	1-CASECLIP
Fitting panel for QuantumX modules, see <i>section 6.3, page 43</i>	Fitting panel for mounting QuantumX modules using case clips (1-CASECLIP), lashing strap or cable ties. Basic fastening by 4 screws.	1-CASEFIT
Case protection for QuantumX modules, see <i>section 6.1, page 38</i>	Case protection (X enclosure frame) for QuantumX modules.	1-CASEPROT

IEEE1394b FireWire		
	Description	Order no.
IEEE1394b FireWire cable (module-to-module)	FireWire connection cable between (lengths: 0.2m/2 m/5 m). Fitted on both ends with appropriate plugs. Note: You have the option to use the cable to supply the modules with voltage (max. 1.5 A, from source to last acceptor).	1-KAB272-0.2 1-KAB272-2 1-KAB272-5
Connection cable, PC to module 3 m	FireWire connection cable between PC and module (ODU, 4,5 m , standard FireWire 1394b). Note: The cable cannot be used to supply QuantumX modules with voltage.	1-KAB293-5
Hub to module connection cable 3 m	FireWire connection cable between hub and modul (length: 3 m). Fitted on both ends with appropriate plugs. Note: The cable can be used to optionally supply connected QuantumX modules with voltage via the hub (max. 1.5 A, from source to last acceptor).	1-KAB276-3
IEEE1394b FireWire PC card	FireWire IEEE 1394b ExpressCard for connecting QuantumX modules at a Notebook or PC.	1-IF-002
IEEE1394b FireWire extender	SCM-FireWire extender, IP68 Package consisting of 2 elements for extending the FireWire connection up to 50 m. Also required: 2x1-KAB269-x and industrial Ethernet cable (M12, CAT5e/6, up to 50 m). Connection via KAB270--3 not possible.	1-SCM-FW
Ethernet		
Ethernet	Ethernet crossover cable, 2 m; CAT5e	1-KAB239-2

Transducer side

General information

Article	Description	Order no.
D-Sub-HD 15-pin plug set with TEDS chip	Plug kit D-Sub HD 15-pin (male) with TEDS chip DS24B33f. Housing: metallized plastic with knurled screws. Note: the TEDS chip is blank.	1-SUBHD15-MALE
D-Sub-HD 15-pin port saver	Four fully wired port savers protect D-Sub-HD 15-pin ports against wear and tear due to frequent plugging and unplugging of transducers. Extends durability by at least 500 contact cycles. Construction: plug in socket with screw connection.	1-SUBHD15-SAVE
D-Sub-HD 15-pin 300 V CAT II adapter	Voltage signal conditioner 300 V (CAT II), TEDS, D-SUB-HD device connection, insulated lab measuring lead (length 0.5 m).	1-SCM-HV
D-Sub-HD 15-pin SG quarter bridge adapter	SG quarter bridge adapter (SCM-SG120 with 120 ohm completion resistor, or SCM-SG350 with 350 ohm completion resistor). Signal conditioning SG quarter bridge on QuantumX input with full bridge. Integrated 120-ohm (350-ohm) completion resistor for quarter bridge, shunt calibration, TEDS, D-Sub-HD device connection, Solder joints for transducer lead in a 3-wire configuration.	1-SCM-SG120 1-SCM-SG350
D-Sub-HD 15-pin to adapter BNC	BNC-socket-to-D-Sub-HD-15-pin-plug adapter for connection of current-fed, piezoelectric sensors (IEPE) or voltage (± 10 V) with BNC to MX410B, MX840B or MX440B (length approx. 5 cm).	1-SUBHD15-BNC

Article	Description	Order no.
Adapter D-Sub-HD 15-pin to D-Sub 15-pin	Adapter D-Sub-HD 15-pin to D-Sub 15-pin for connecting transducers with pre-assembled D-Sub plugs on MX840 (length approx. 0.3 m). Note: Ready-made for full-bridge (6-wire).	1-KAB416
Push-In connector (8 Pins), Gold	10 push-in-connectors, Phönix Contact, 8 Pins, Gold, (Module: MX1601B, MX1615B, MX879B). Note: Do not connect these gold plugs to MX1601 or MX615 devices (risk of corrosion!).	1-CON-S1015
1-wire EEPROM DS24B33	Package consisting of 10 units 1-wire EEPROM DS24B33 (for TEDS as per IEEE 1451.4.).	1-TEDS-PAK



Software and product packages



Article	Description	Order no.
catman [®] EASY	Easy-to-use HBM software for data acquisition and analysis. Configuration of data acquisition system, channels and signals. Creation of individual panels for signal visualization. Data storage in different formats (e.g. BIN, Excel, ASCII, DIAdem, MATLAB, MDF). Graphical analysis of stored measurement data, with the option to export graphics (e.g. into Word).	1-CATMAN-EASY
catman [®] AP	Upgrades catman [®] EASY with: <ul style="list-style-type: none"> - EasyMath for mathematical post-process analysis and export of measurement data - EasyVideocam integration of up to 4 video cameras (Windows DirectShow, USB / Ethernet / FireWire) - EasyPlan for offline parameterization (Wizard or Microsoft EXCEL[®]) - EasyScript for automatic processes (Visual Basic for Applications) - EasyRoadload for integration of Kistler RoadDyn[®] measuring wheels 	1-CATMAN-AP

MX840B, MX440B accessories

Article	Description	Order no.
Cold junction for thermocouple on MX840B, MX440B	<p>Electronics for temperature compensation for measurements with thermocouples on MX840B, MX440B, consisting of:</p> <ul style="list-style-type: none"> - PT1000 cold junction - Including 1-wire TEDS chip for transducer identification <p>Note: Mounting in D-Sub-HD 15-pin transducer plug.</p>	1-THERMO-MXBOARD
Adapter D-Sub-HD15 to D-Sub 9 (CAN) for MX840B	Adapter for connecting CAN devices on MX840B, MX440B D-Sub-HD 15-pin (plug) to D-Sub 9-pin (socket); (length: approx. 30 cm).	1-KAB418

MX403B accessories

Article	Description	Order no.
<p>Adapter BNC</p>  <p>Shrouded plug</p>	BNC socket adapter to 2 shrouded plugs with standardized gap, 4 pieces per Set. 1000 V CATII, 600 V CATIII.	1-G067-2
<p>„Artificial star“ to banana plug adapter</p> 	Pluggable artificial star for attaching to the MX403B.	1-G068-2
Safety laboratory cable	Insulated black/red lead set, 1.5 meters with safety-shrouded banana plugs and alligator clips 1000V CAT II.	1-KAB282-1,5

Article	Description	Order no.
<p>HBR 1 Ω, 1 W precision burden resistor</p> 	<p>1 Ω, 1 W, 0.02% high precision, low thermal drift burden resistor. Internally uses 4 wire connection to reduce inaccuracy caused by the currents running to the burden resistor. Using banana input connectors and banana output pins. Directly compatible with GN610, GN611, GN610B and GN611B acquisition cards.</p>	<p>1-HBR/1 Ohm</p>
<p>HBR 2.5 Ω, 1 W precision burden resistor</p> 	<p>2.5 Ω, 1 W, 0.02% high precision, low thermal drift burden resistor. Internally uses 4 wire connection to reduce inaccuracy caused by the currents running to the burden resistor. Using banana input connectors and banana output pins. Directly compatible with GN610, GN611, GN610B and GN611B acquisition cards.</p>	<p>1-HBR/1.5 Ohm</p>
<p>HBR 10 Ω, 1 W precision burden resistor</p> 	<p>10 Ω, 1 W, 0.02% high precision, low thermal drift burden resistor. Internally uses 4 wire connection to reduce inaccuracy caused by the currents running to the burden resistor. Using banana input connectors and banana output pins. Directly compatible with GN610, GN611, GN610B and GN611B acquisition cards.</p>	<p>1-HBR/10 Ohm</p>

MX1609 accessories

Article	Description	Order no.
Bag with 10 mini thermocouple plugs, incl. RFID for thermocouples type K	Package, consisting of 10 x mini thermocouple plugs with integrated RFID chip for measuring point detection for the MX1609/KB thermocouple measuring amplifier of the QuantumX family; type K: NiCr-NiAl, RFID integrated, green, male.	1-THERMO-MINI
Bag with 10 mini thermocouple plugs, incl. RFID for thermocouples type T	Package, consisting of 10 x mini thermocouple plugs with integrated RFID chip for measuring point detection for the MX1609/TB thermocouple measuring amplifier of the QuantumX family; type T: Cu-CuNi, RFID integrated, brown, male.	1-THERMO-MINI-T

MX879B, MX1601B, 1615B accessories

Article	Description	Order no.
Push-In connector (8 pins)	10 Push-In connectors, Phoenix Contact, 8 pins (modules: MX1601B, MX1615B, MX879B).	1-CON-S1005

Phoenix Push-In-Connector
with strain relief

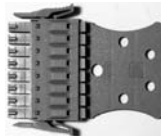

MX809B accessories

Artikel	Beschreibung	Bestell-Nr.
Thermo Mini insulating cap	Kit comprising a total of 4 insulating caps (ISOCAP) to allow for self-assembly of Thermo Mini sockets of type K, J, T, B, E, N, R, S, C or copper thermocouples for measuring voltages of ± 5 V.	1-CON-A1018

12.1 System accessories

12.1.1 BPX001 backplane

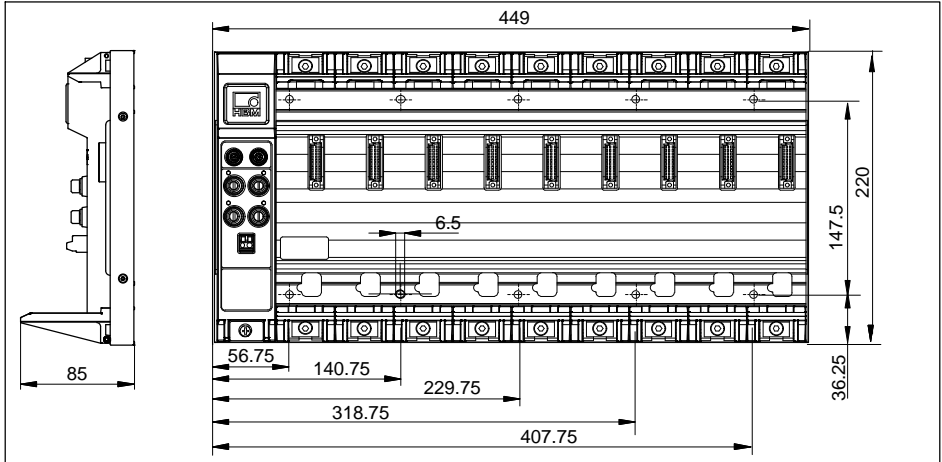

12.1.2 BPX002 backplane

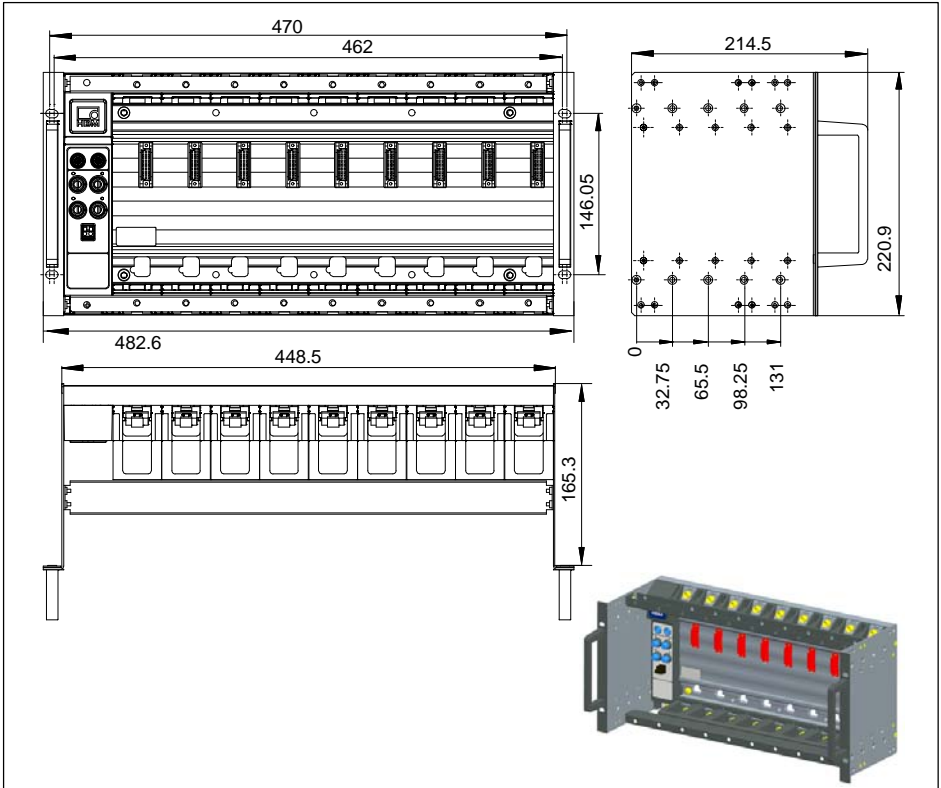

12.1.3 Housing connection elements

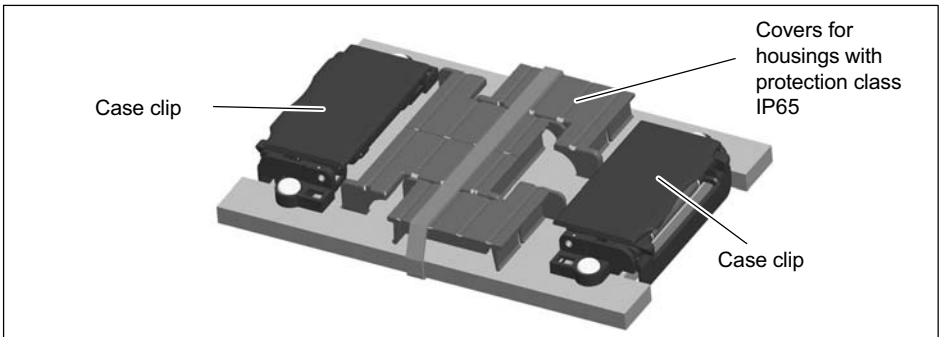

12.2 Voltage supply

12.2.1 Power pack NTX001

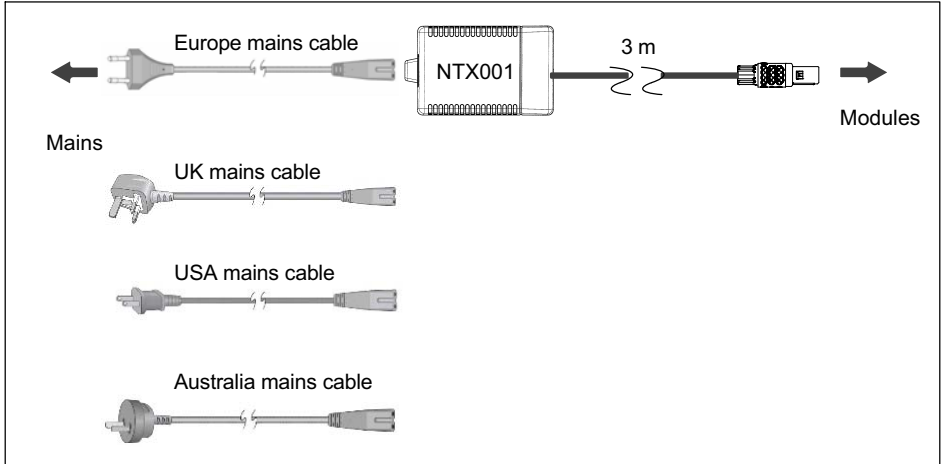

Order number: 1-NTX001

12.2.2 Supply cable

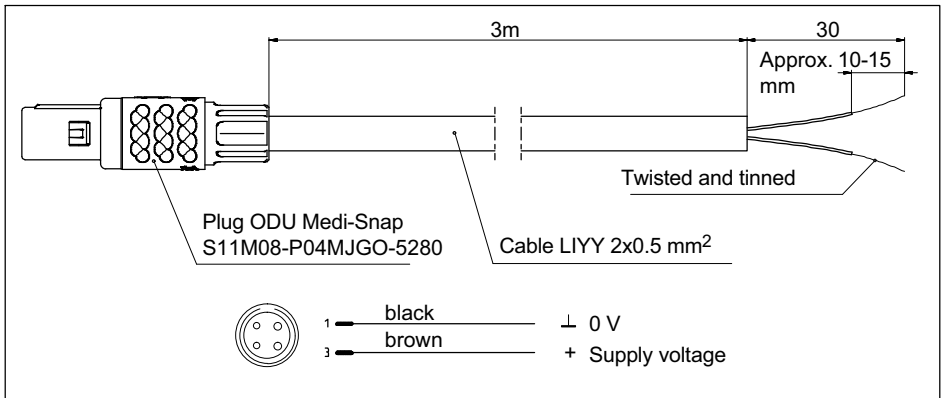

Order number: 1-Kab271-3 (length 3 m)

12.3 IEEE1394b FireWire

12.3.1 IEEE1394b FireWire cable (module-to-module; IP67)

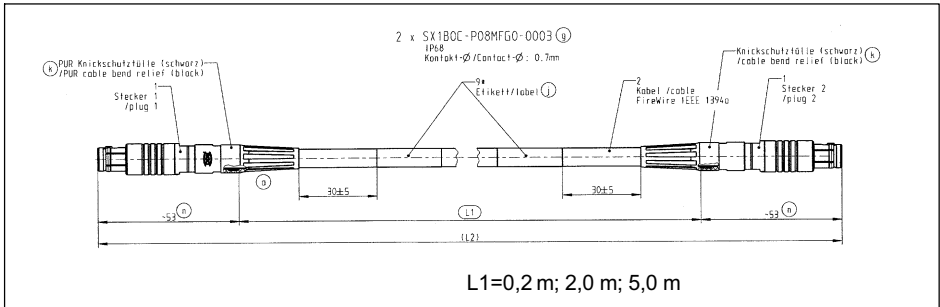

- Order numbers:** 1-KAB272-0.2 (length 0.2 m)
 1-KAB27-2 (length 2 m)
 1-KAB272-5 (length 5 m)

12.3.2 Connection cable (PC to module)

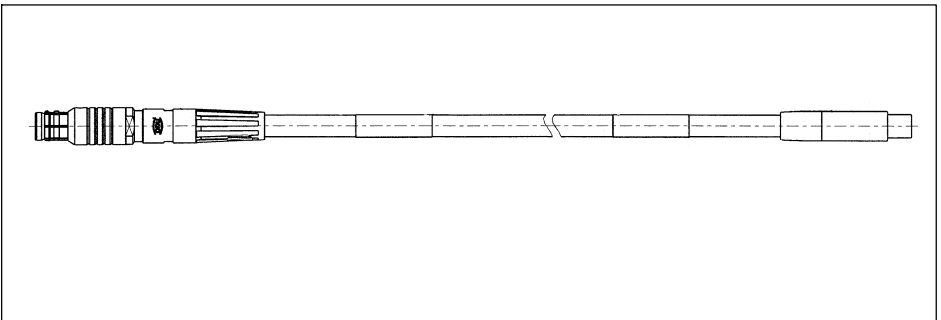

- Order number:** 1-KAB293-5 (length 5 m)

12.3.3 Connection cable (PC to hub)

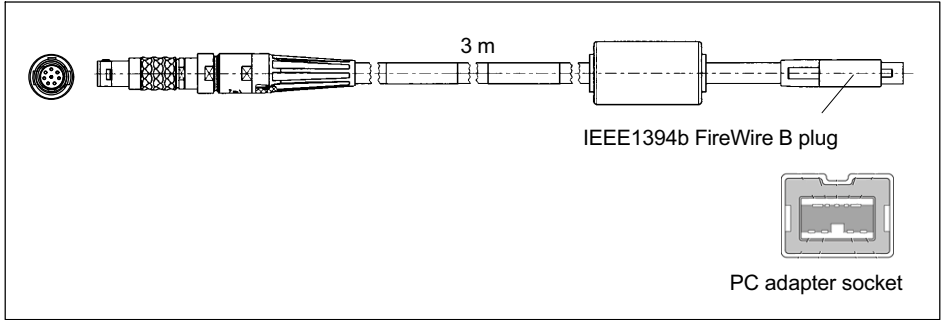

Order number: 1-KAB276-3 (length 3 m)

12.4 General information

12.4.1 Plug kit with TEDS chip

Plug kit D-Sub-HD 15-pin (male) with TEDS chip for storing a sensor data sheet.



Order number: 1-SUBHD15-MALE

12.4.2 Port saver Sub-HD 15-pin



Order number: 1-SUBHD15-SAVE

When frequently connecting and disconnecting transducers we recommend that you use port savers for protecting the transducer sockets of the QuantumX module. The port saver is easy to screw into place and can be replaced after several hundred mating cycles. This eliminates that need for expensive module repairs.

12.4.3 Adapter D-Sub-HD 15-pin to D-Sub 15-pin

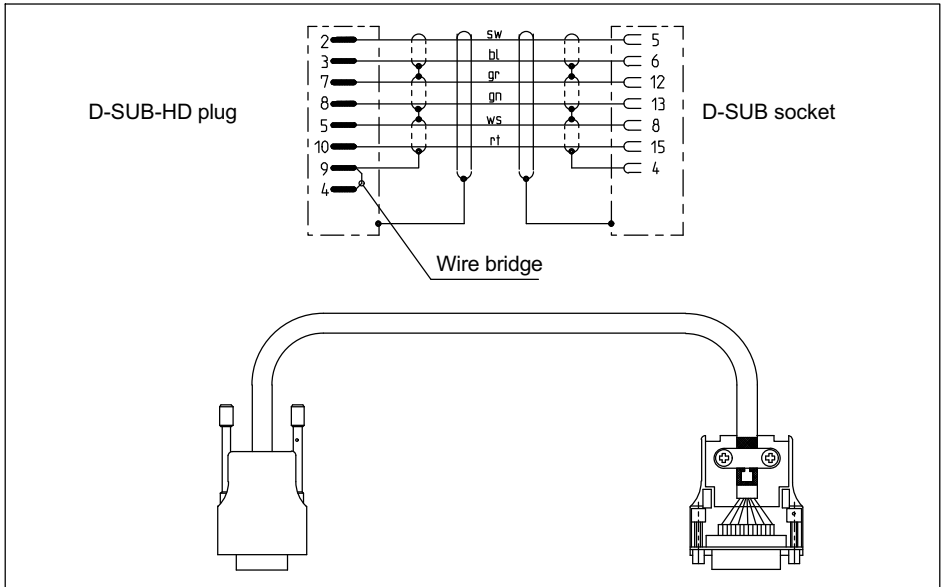

Order number: 1-KAB416

CAUTION

This cable is only for transducers with full bridge and 6-wire circuits! If other transducers are connected, the universal amplifier can be damaged or even destroyed.

12.5 Accessories for MX840B, MX440B

12.5.1 Cold junction for thermocouples

Electronics for temperature compensation for measurements with thermocouples. Board for installation in a 15-pin D-Sub-HD plug.

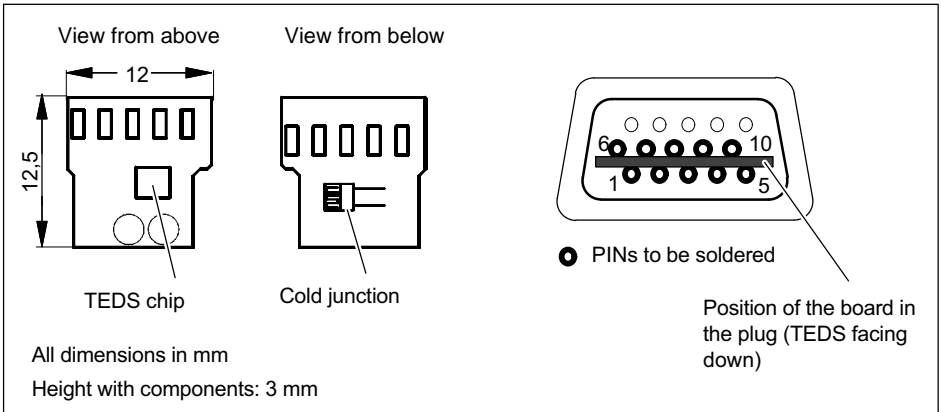

Order number: 1-THERMO-MXBOARD

12.6 SubHD15 to BNC adapter

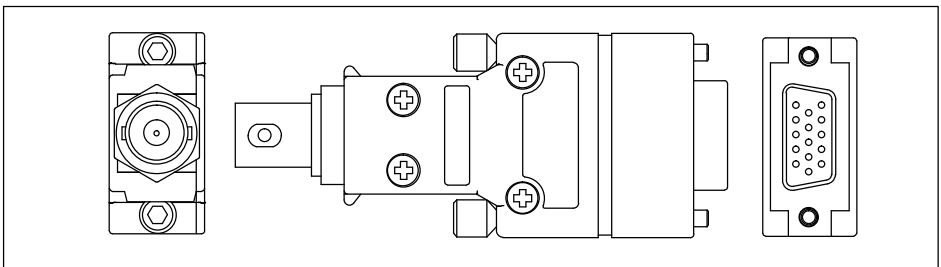

Order number: 1-SUBHD15-BNC

The adapter from D-Sub-HD plug male to BNC socket is used to connect current fed piezoelectric transducers (IEPE = Integrated Electronics Piezo Electric) or electrical voltages with BNC connector cable to universal amplifier MX410B as well as MX840B or MX440B.

12.7 SCM-HV accessories



Order number: 1-SCM-HV

High-voltage signal conditioner for measuring differential voltages within the rated data indicated in the specifications together with a suitable QuantumX module.

Connection to 15-pin sockets of QuantumX modules MX840B, MX440B or MX410B

12.8 SCM-SG120/350 quarter bridge adapter

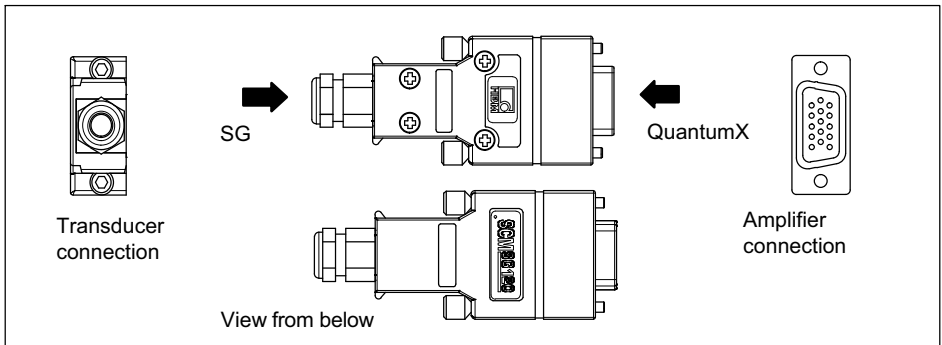

Order number: 1-SCM-SG120/350

Bridge adapter SCM-SG120/350 is inserted into QuantumX modules with SG full bridge input (D-Sub-HD15). This makes it possible to connect a SG in quarter bridge circuit in 3-wire configuration.

12.9 MX1609/KB/TB accessories

12.9.1 Thermo-connector with integrated RFID chip

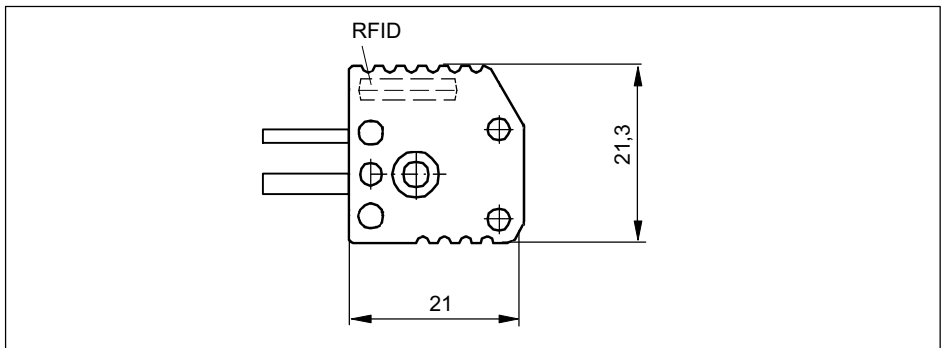

Connectors for thermocouple amplifiers:

MX1609 / MX1609KB: type K

Package unit: 10 mini connectors for thermocouples type K

Order number: 1-THERMO-MINI

MX1609T/TB: Type T

Package unit: 10 mini connectors for thermocouples type T

Order number: 1-THERMO-MINI-T

13 Support

Headquarters world-wide

Europe

Hottinger Baldwin Messtechnik GmbH:
Im Tiefen See 45, 64293 Darmstadt, Germany
Tel. +49 6151 8030, Fax +49 6151 8039100
E-mail: info@hbm.com
www.hbm.com

North and South America

HBM, Inc., 19 Bartlett Street, Marlborough, MA 01752, USA
Tel. +1-800-578-4260 / +1-508-624-4500,
Fax +1-508-485-7480
E-mail: info@usa.hbm.com

Asia

Hottinger Baldwin Measurement (Suzhou) Co., Ltd.
106 Heng Shan Road, Suzhou 215009, Jiangsu, VR China
Tel. (+86) 512 68247776, Fax (+86) 512 68259343
E-mail: hbmchina@hbm.com.cn

Up-to-date addresses of representatives can also be found on the Internet at:
[www.hbm.com/Contact/International sales offices](http://www.hbm.com/Contact/International_sales_offices)

托驰（上海）工业传感器有限公司
上海市嘉定区华江路348号1号楼707室
电话: +86 021 51069888
传真: +86 021 51069009
邮箱: zhang@yanatoo.com
网址: www.sensor-hbm.com

measure and predict with confidence

